

Correzione delle figure del libro “Fondamenti di Informatica in Java”

Emilio Di Giacomo, Walter Didimo

Per un problema in fase di stampa, alcune linee di alcune figure non appaiono correttamente visualizzate. Nel seguito vengono riportate le figure visualizzate in maniera corretta.



Figura 3.1, pag 58



Figura 4.6, pag 89

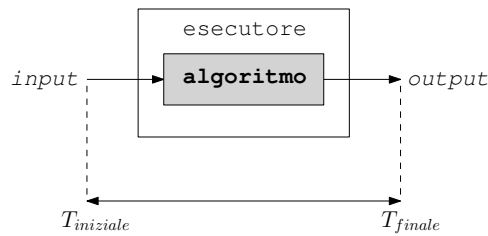

Figura 4.7, pag 89

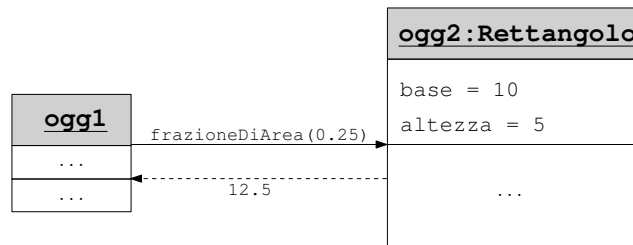

Figura 4.9, pag 91

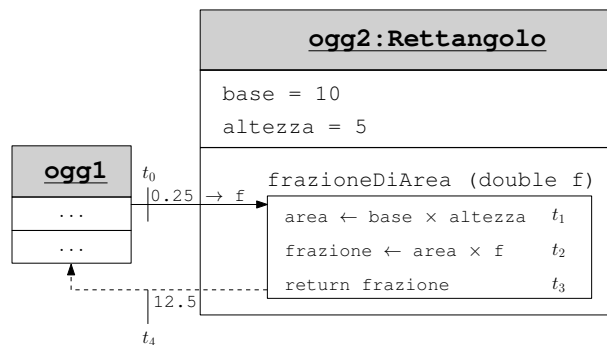

Figura 5.4, pag 103

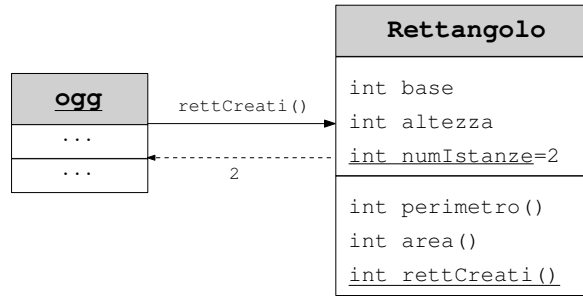

Figura 5.6, pag 106

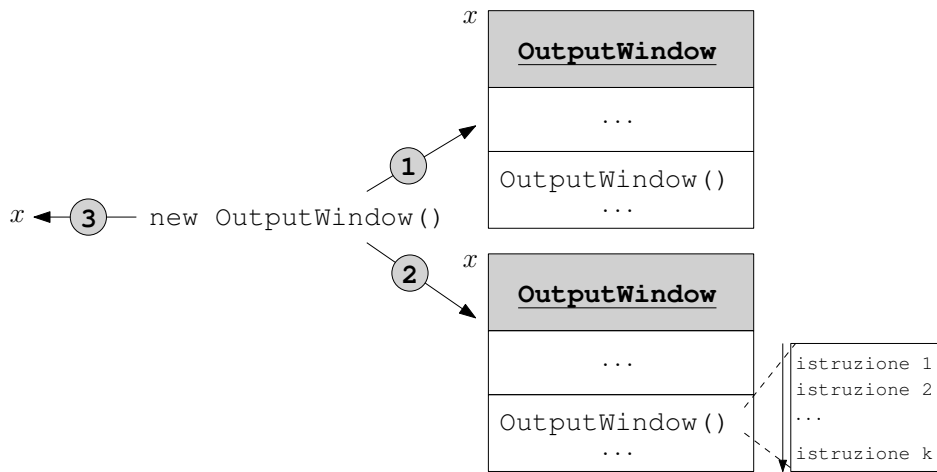

Figura 5.9, pag 122

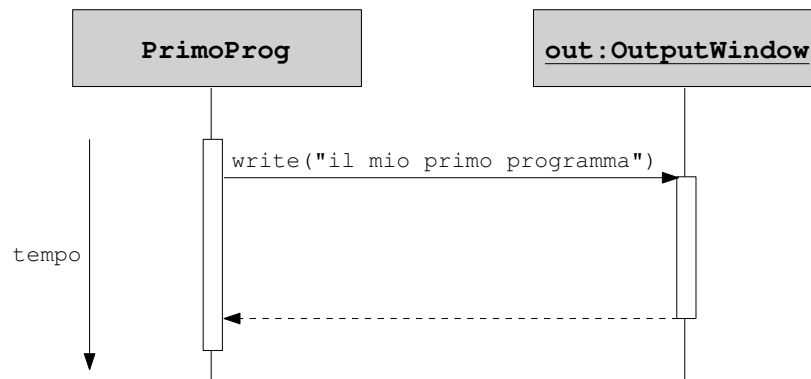

Figura 9.1, pag 236

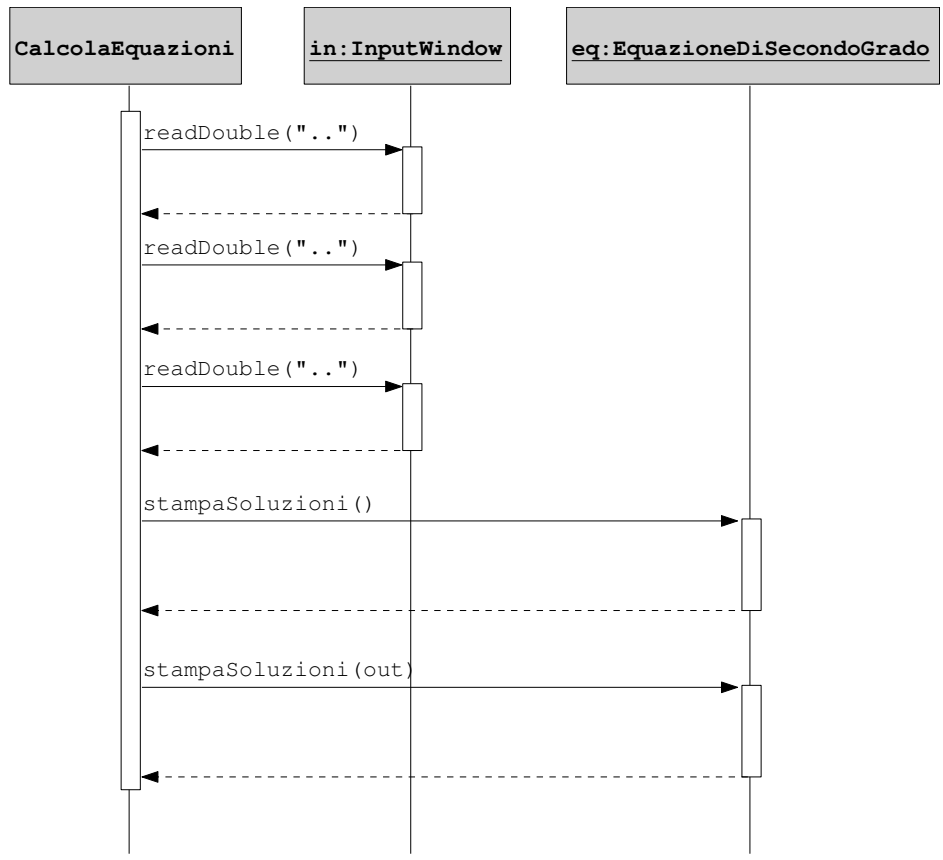

Figura 9.2, pag 237

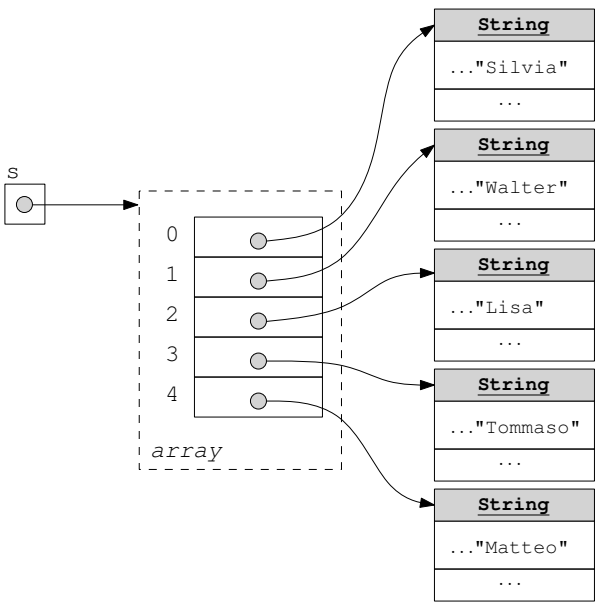

Figura 9.3, pag 240

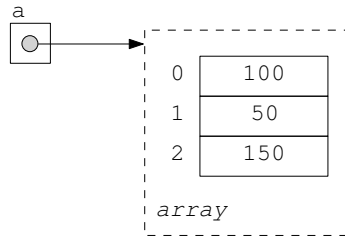

Figura 9.4, pag 242

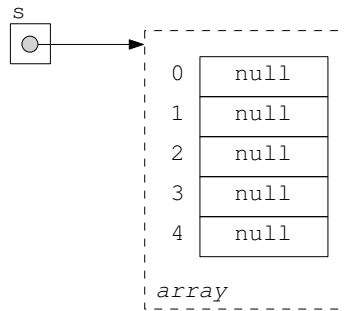

Figura 9.5, pag 242

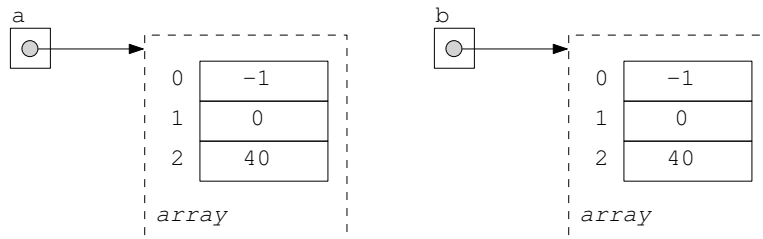

(a)

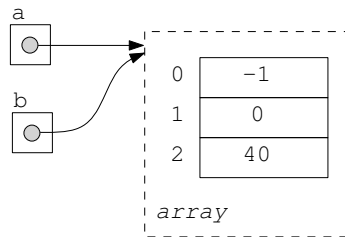
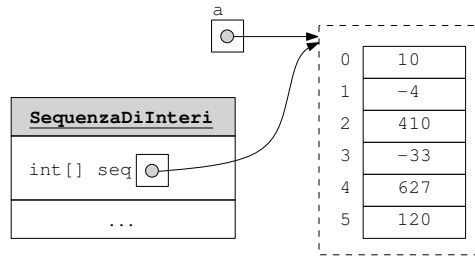
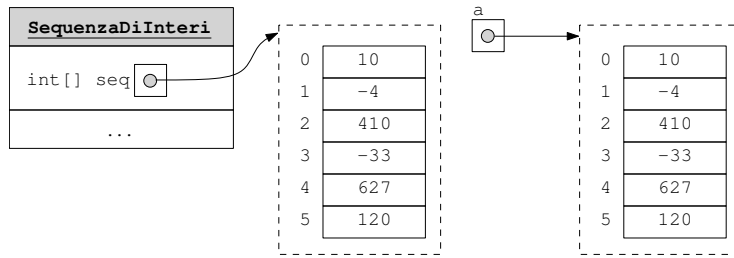

(b)

Figura 9.7, pag 245



Figura 9.6, pag 243



Figura 9.8, pag 247

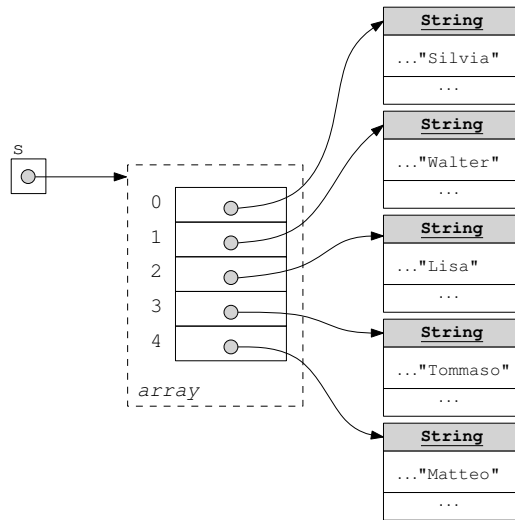

Figura 9.9, pag 254

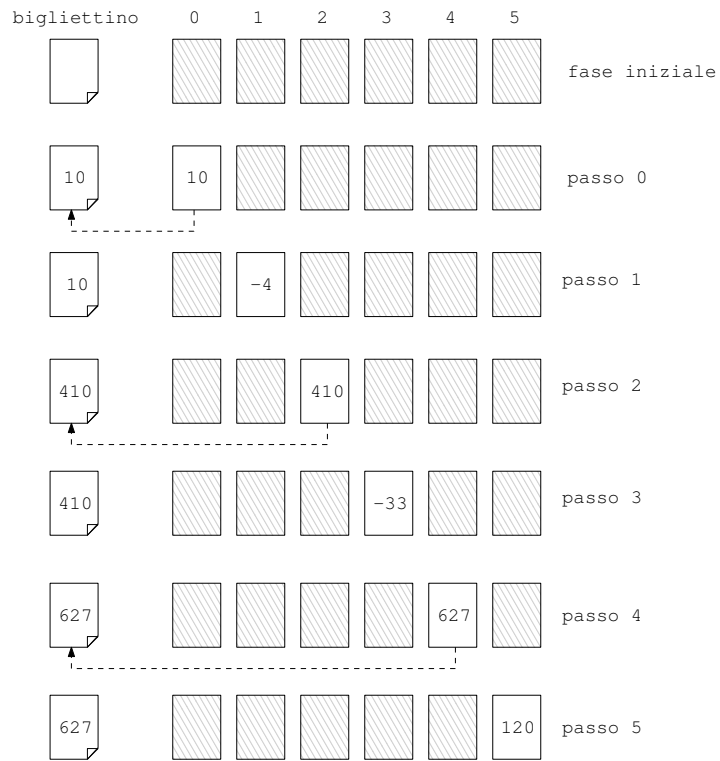

Figura 9.11, pag 256

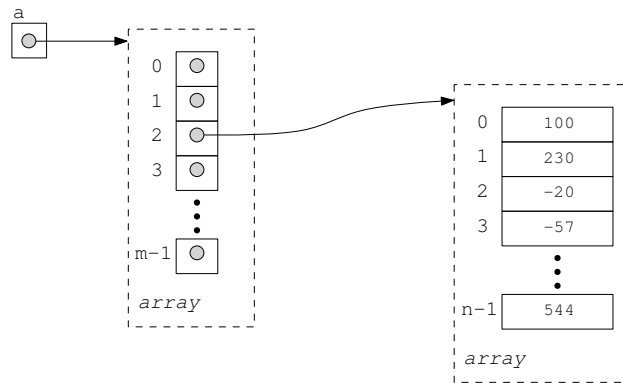

Figura 9.10, pag 256

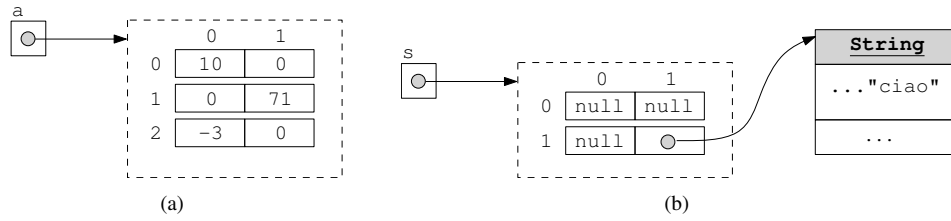

Figura 9.12, pag 257

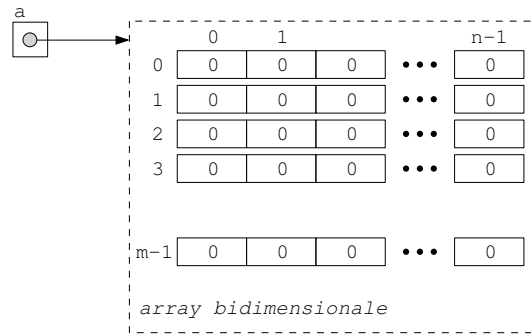

Figura 10.4, pag 291

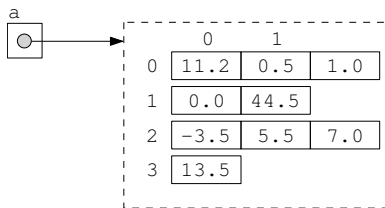

Figura 10.5, pag 293

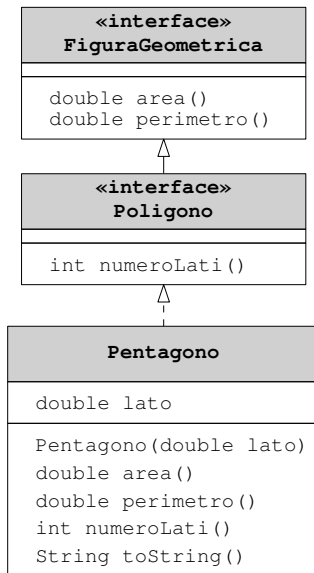

(a)

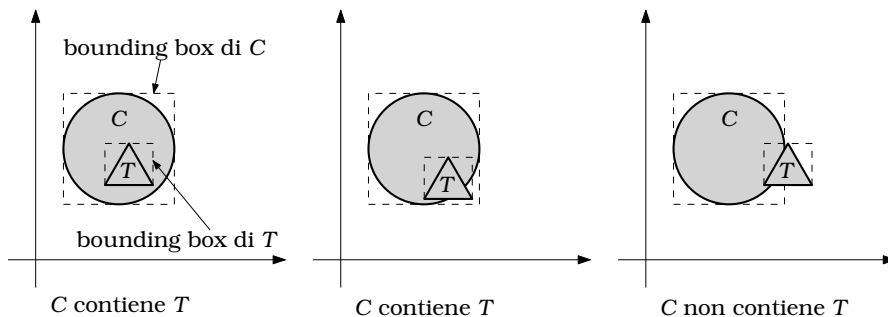
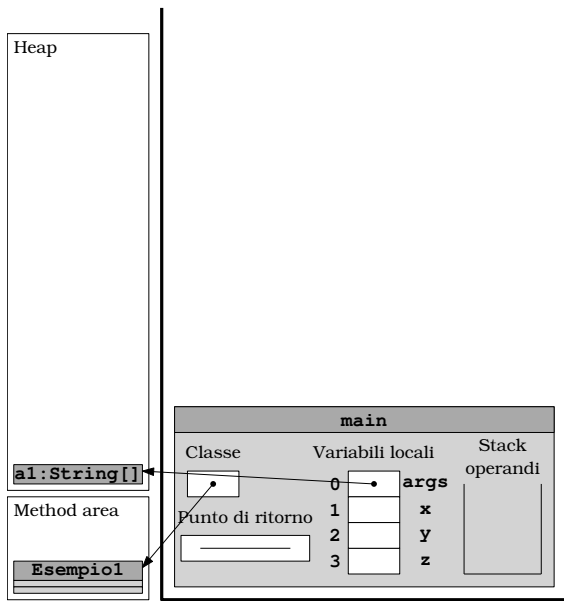
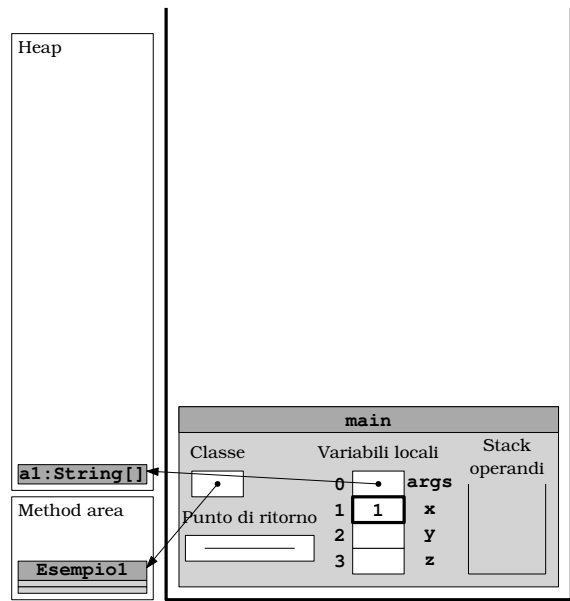

(b)

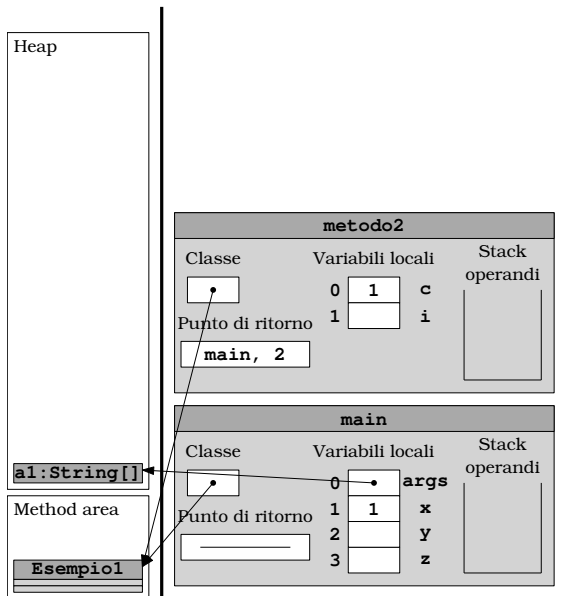

(c)

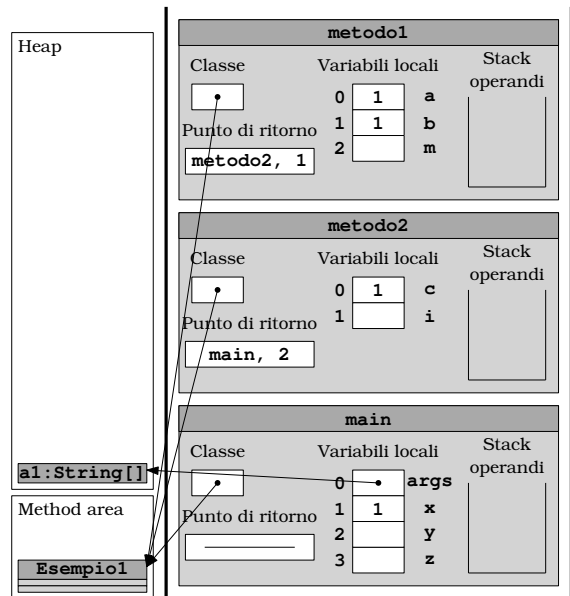

(d)

Figura 11.3, Pag 313

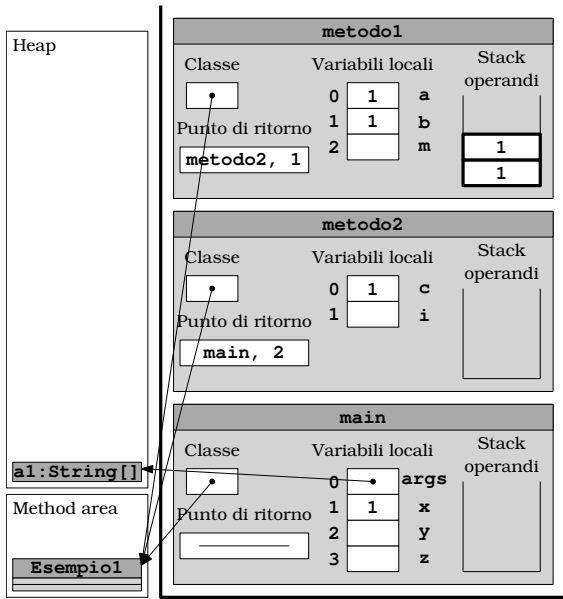

(e)

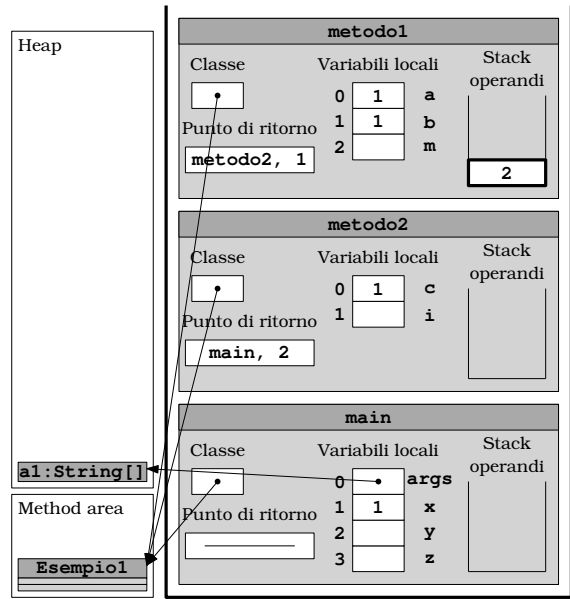

(f)

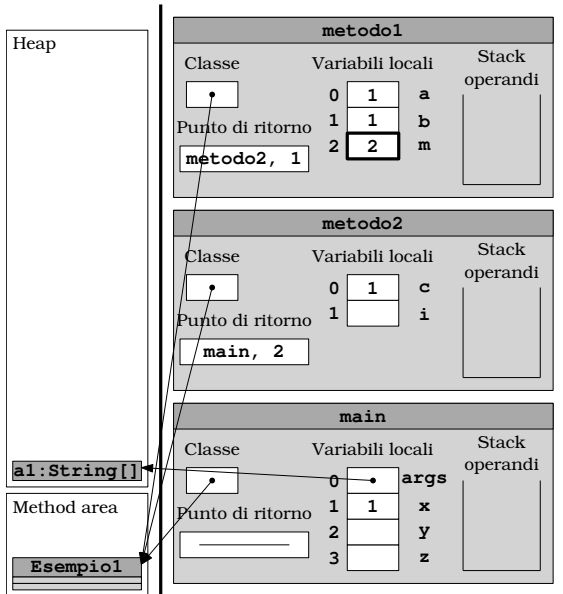

(g)

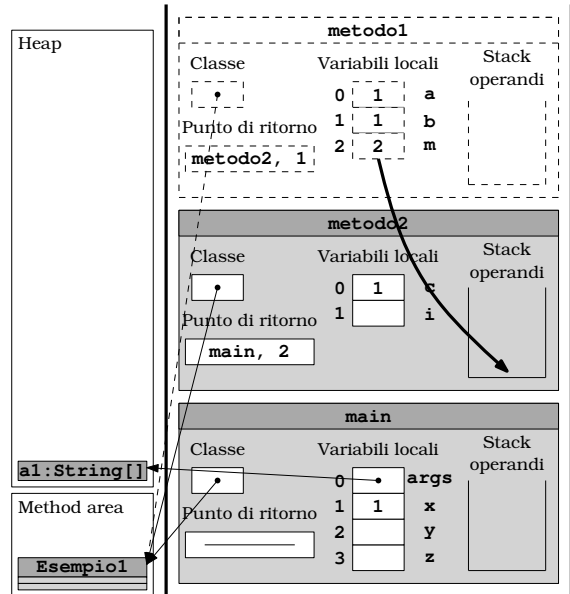

(h)

Figura 11.4, Pag 314

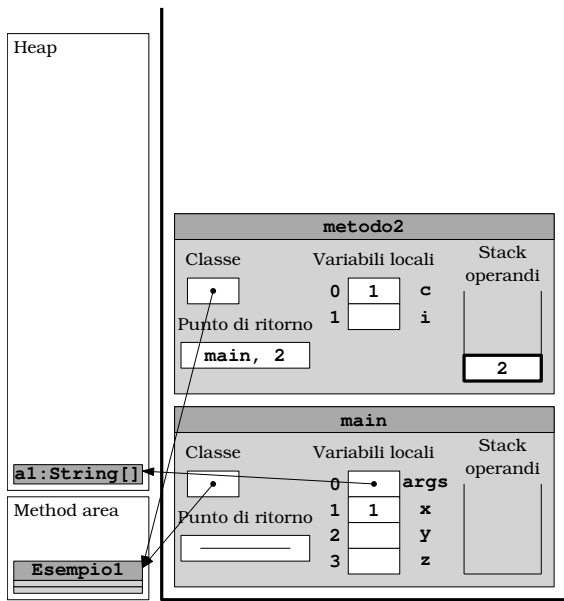

(a)

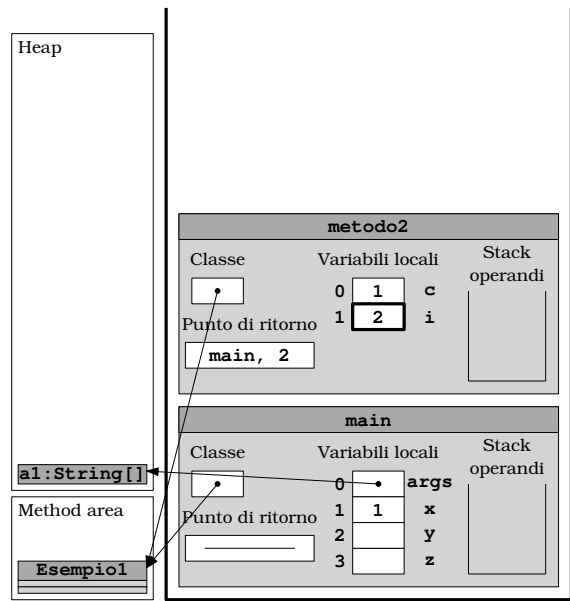

(b)

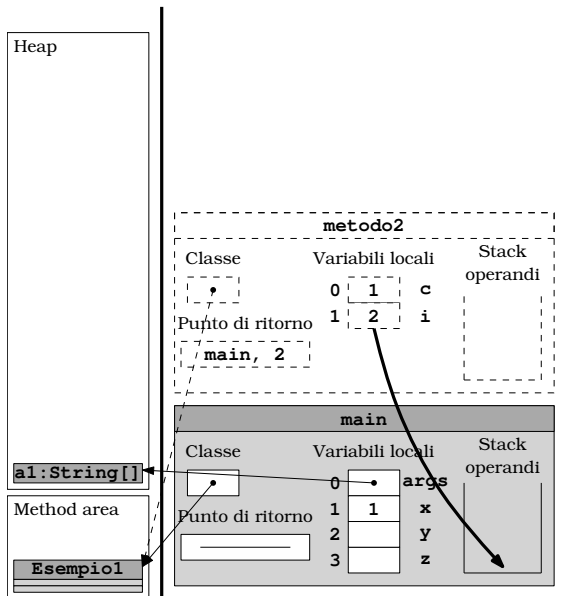

(c)

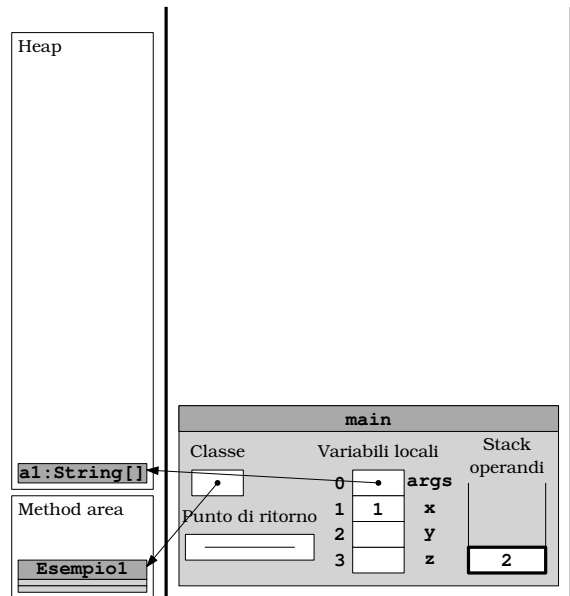

(d)

Figura 11.5, Pag 315

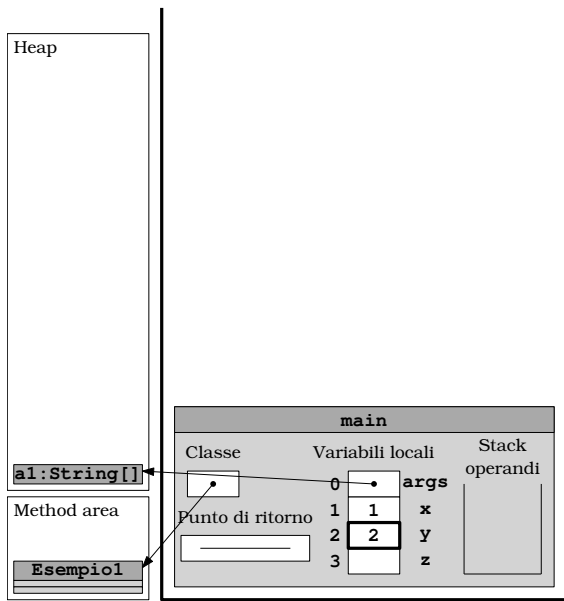

(a)

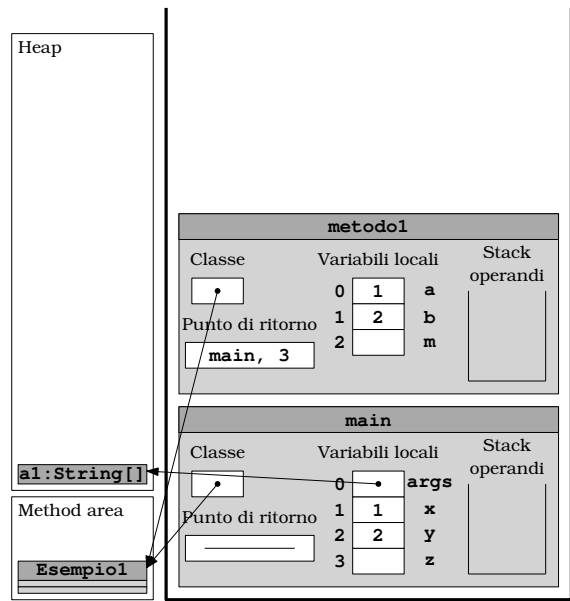

(b)

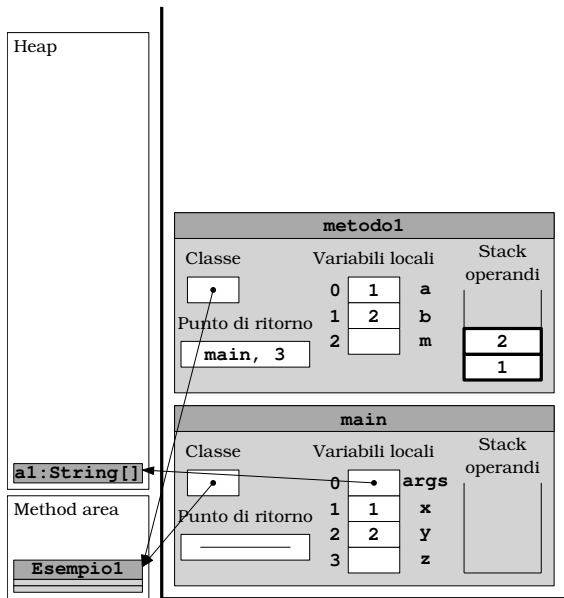

(c)

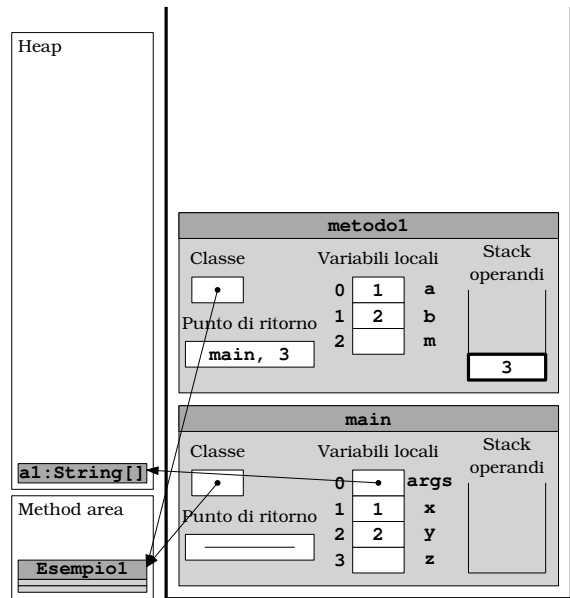

(d)

Figura 11.6, Pag 316

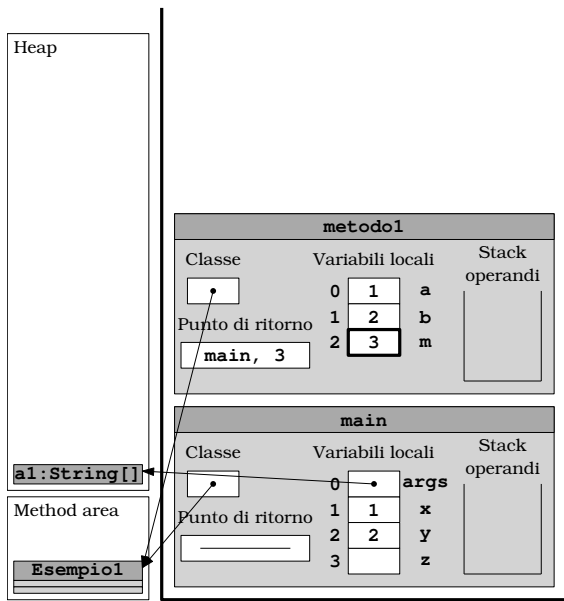

(a)

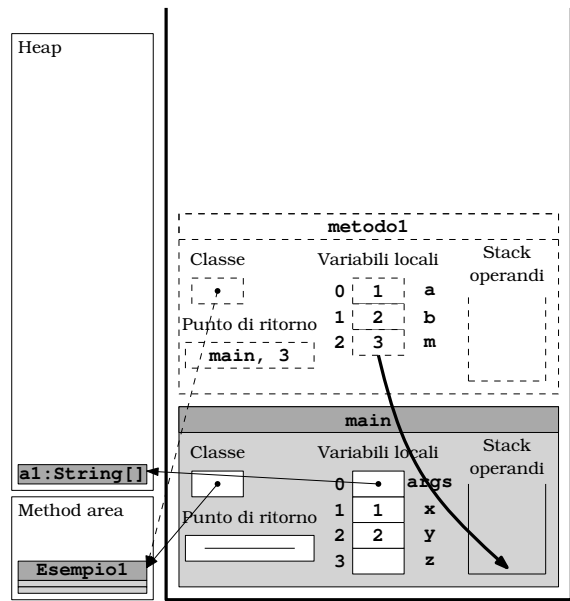

(b)

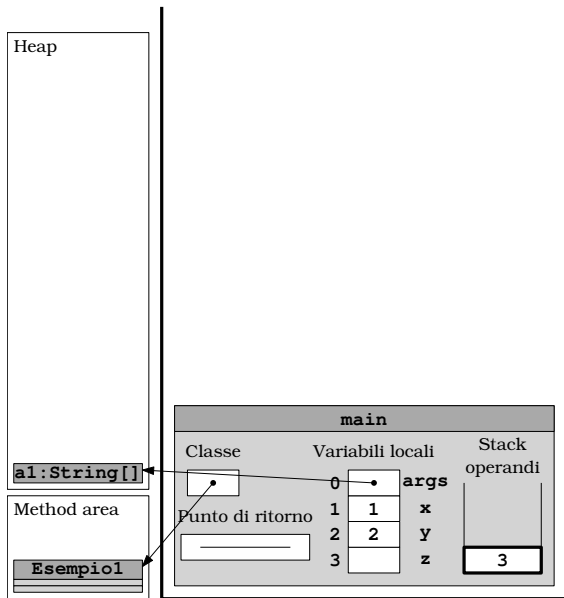

(c)

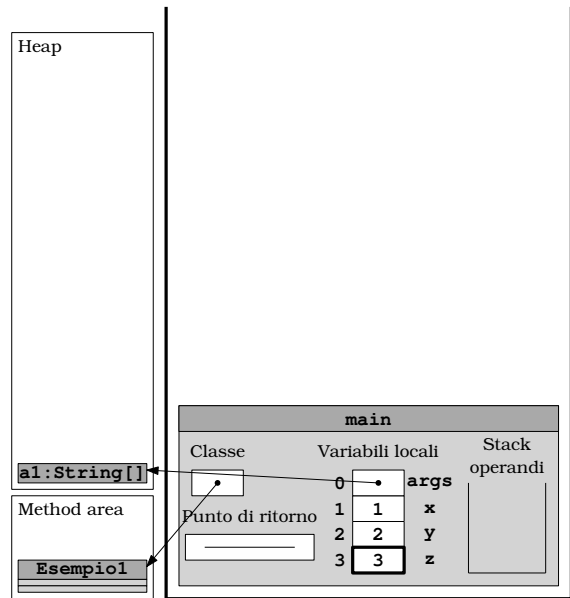

(d)

Figura 11.7, Pag 317



Figura 11.8, Pag 318



(a)

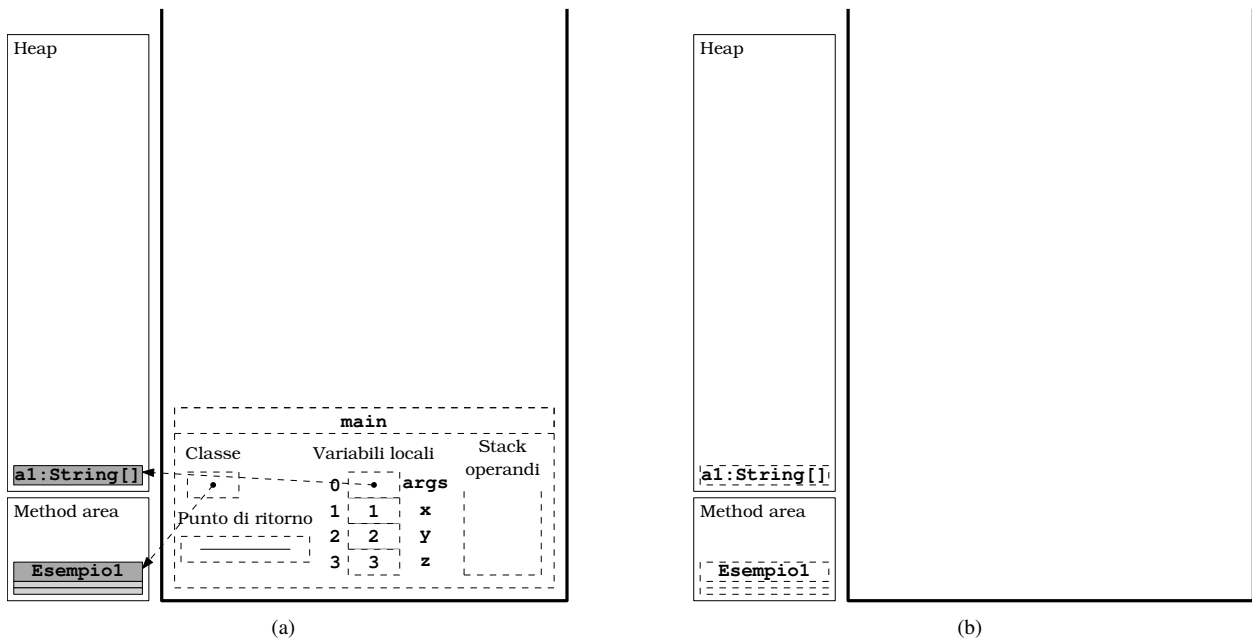
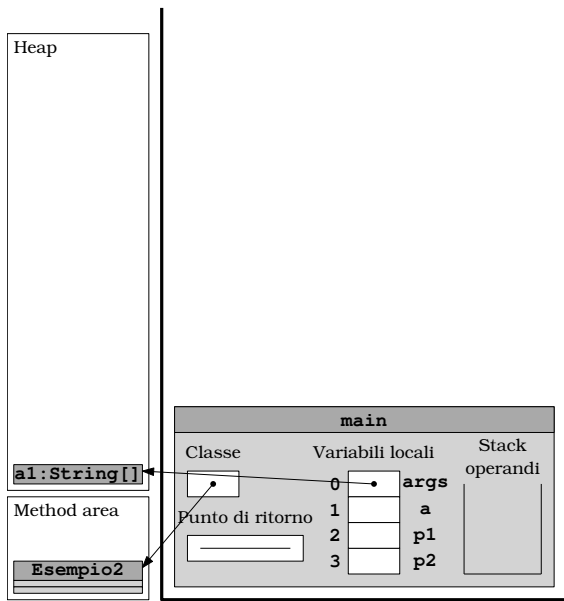
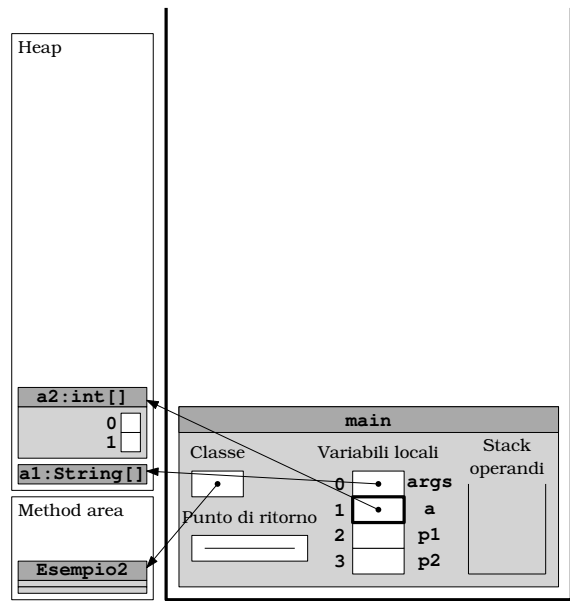

(b)

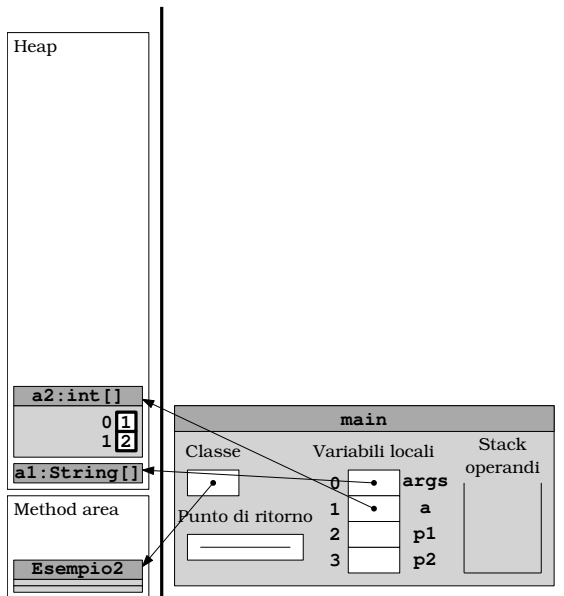

(c)

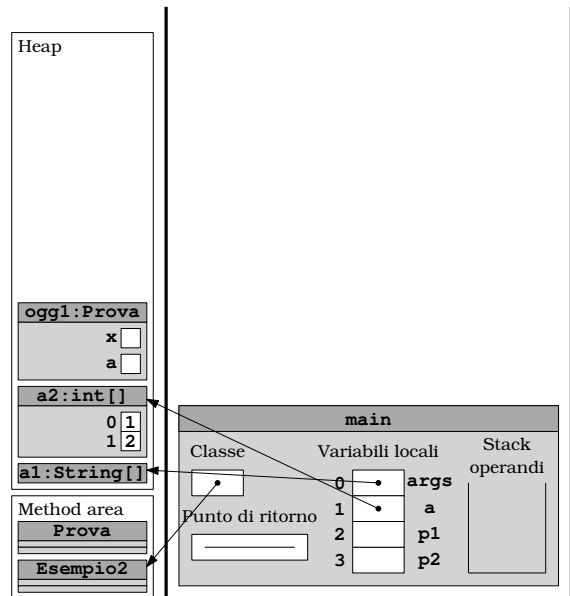

(d)

Figura 11.9, Pag 322

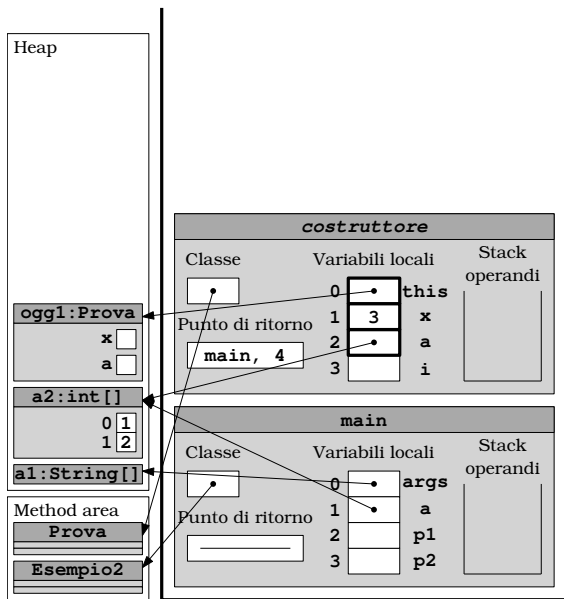

(a)

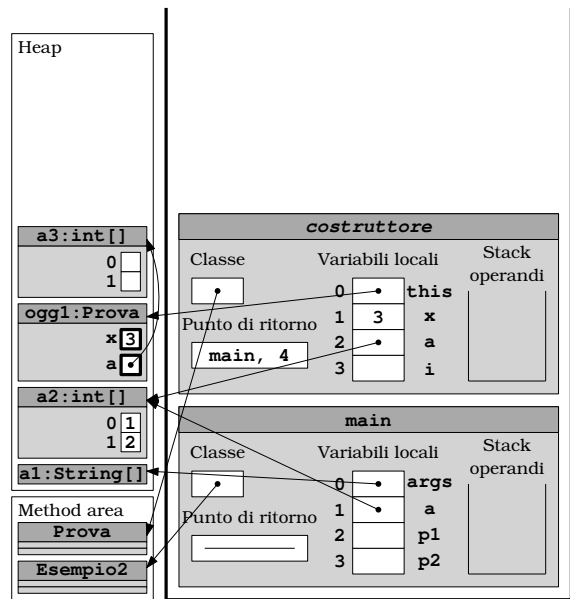

(b)

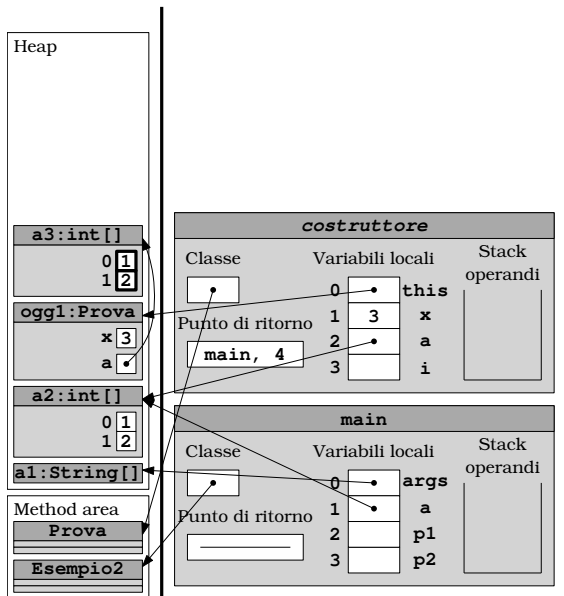

(c)

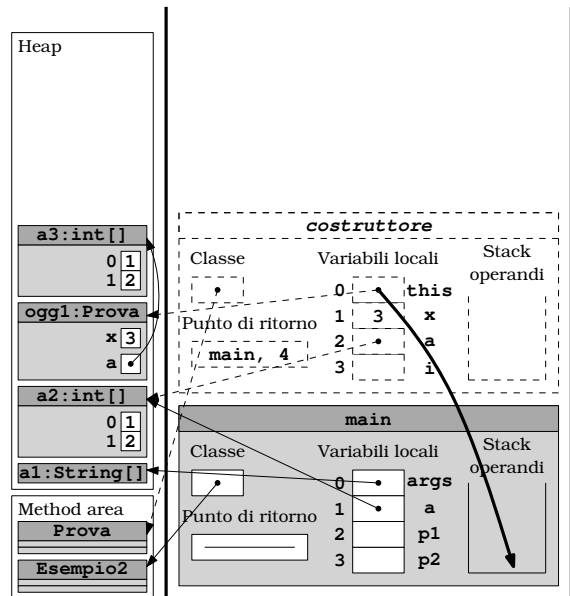

(d)

Figura 11.10, Pag 323

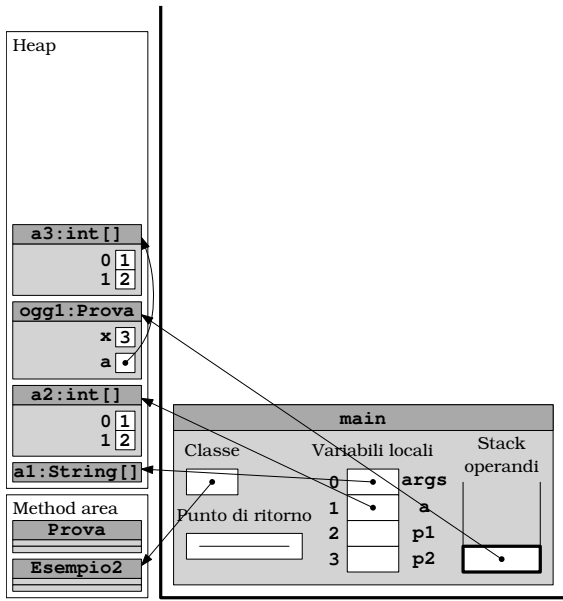

(a)

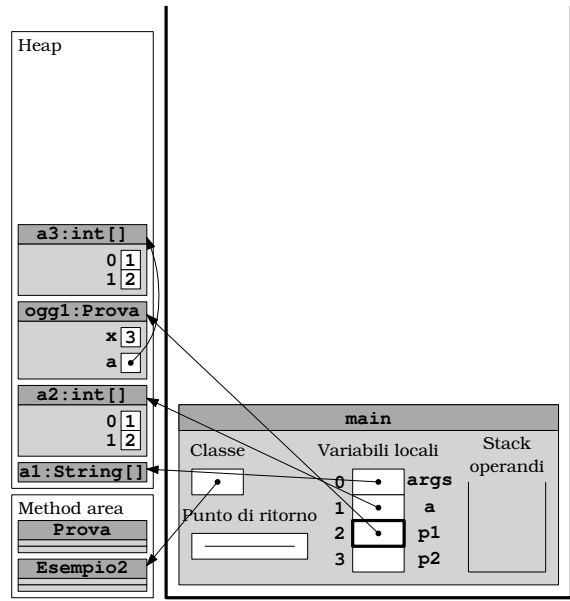

(b)

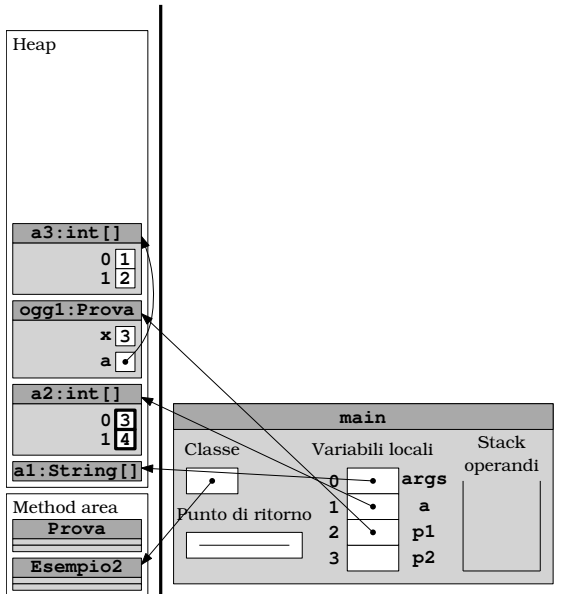

(c)

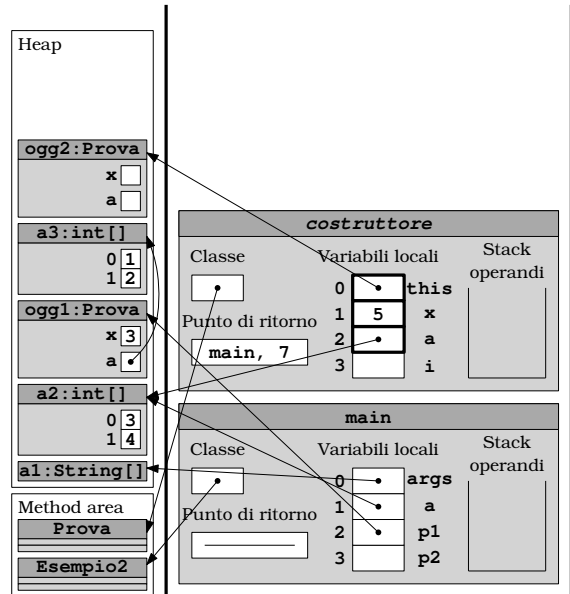

(d)

Figura 11.11, Pag 324

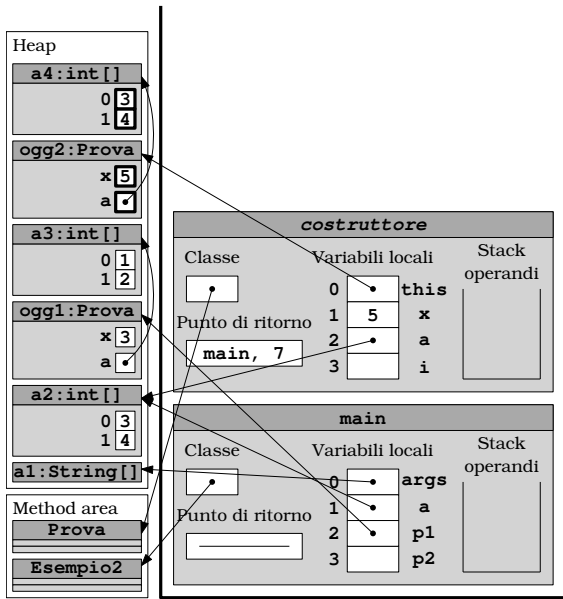

(a)

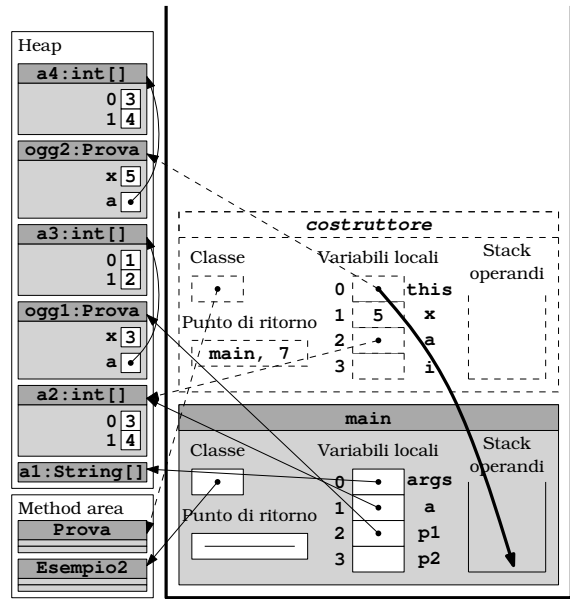

(b)

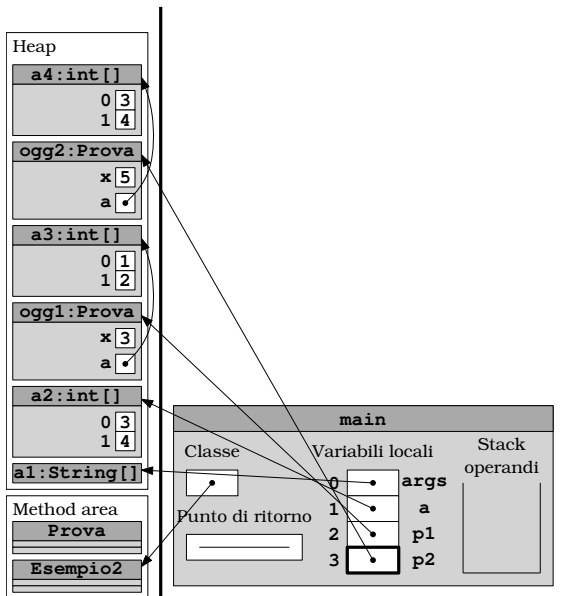

(c)

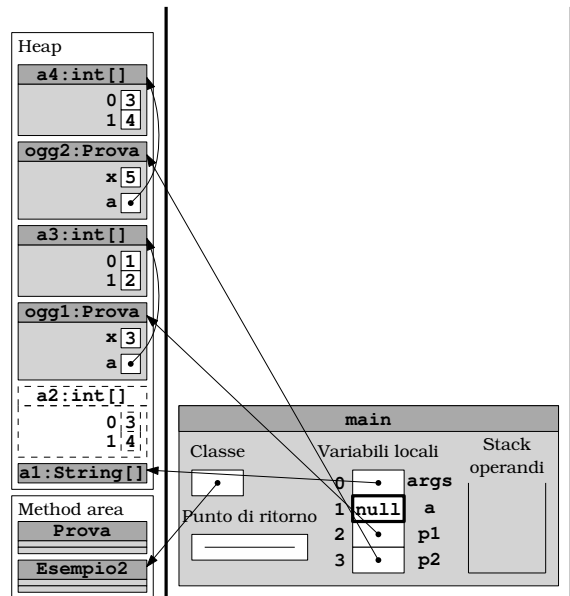

(d)

Figura 11.12, Pag 325

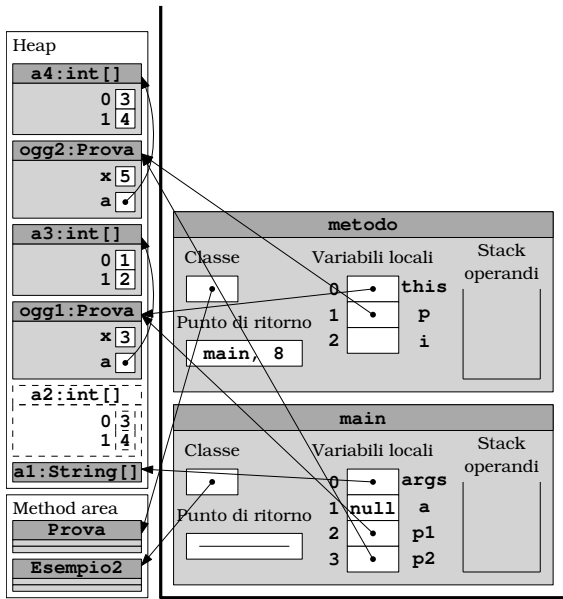

(a)

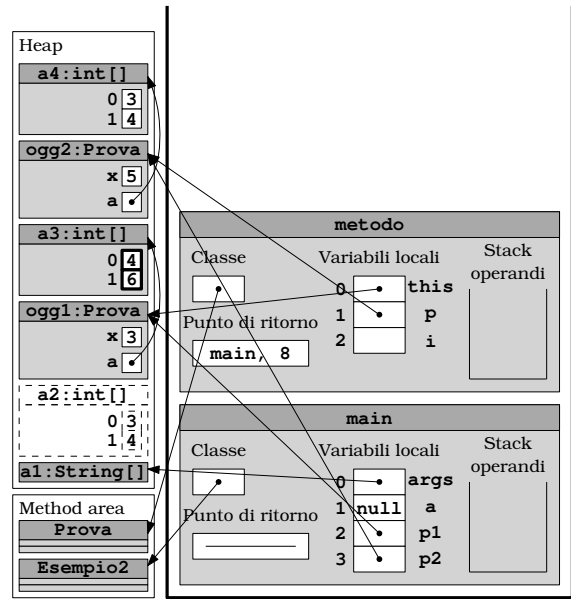

(b)

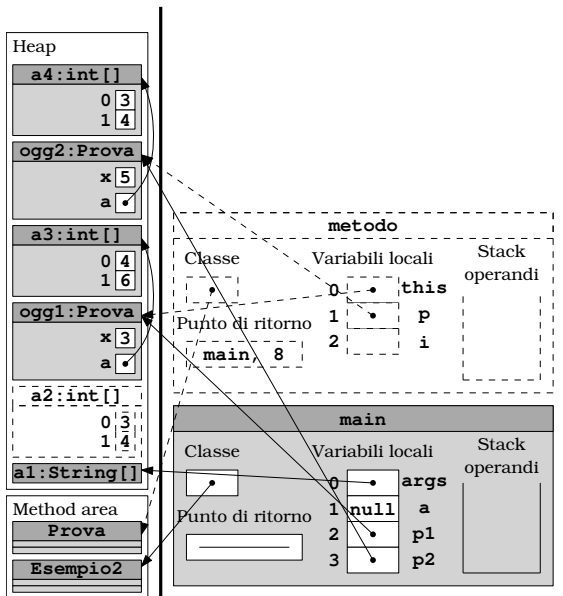

(c)

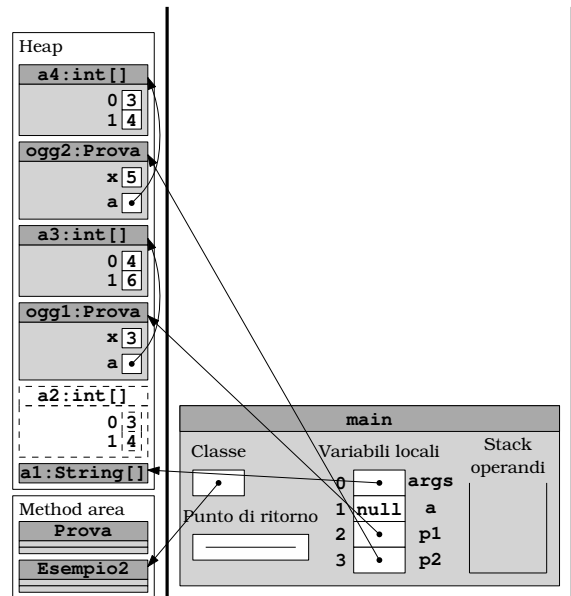

(d)

Figura 11.13, Pag 326

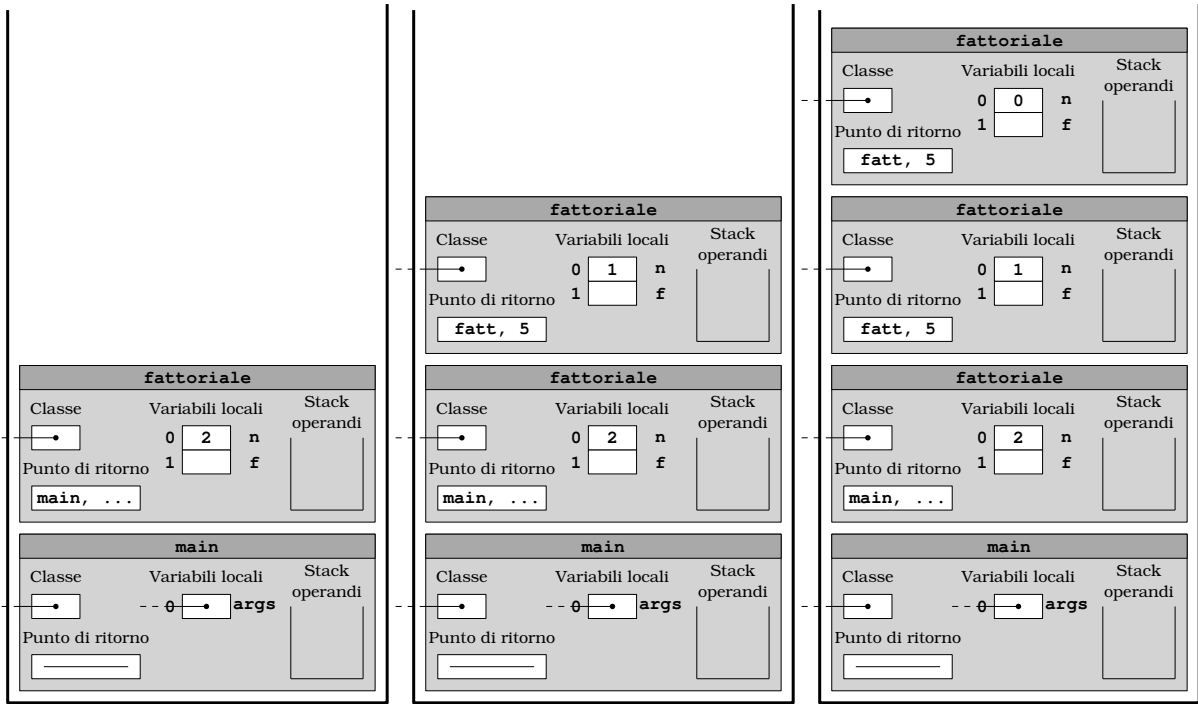

(a)

(b)

(c)

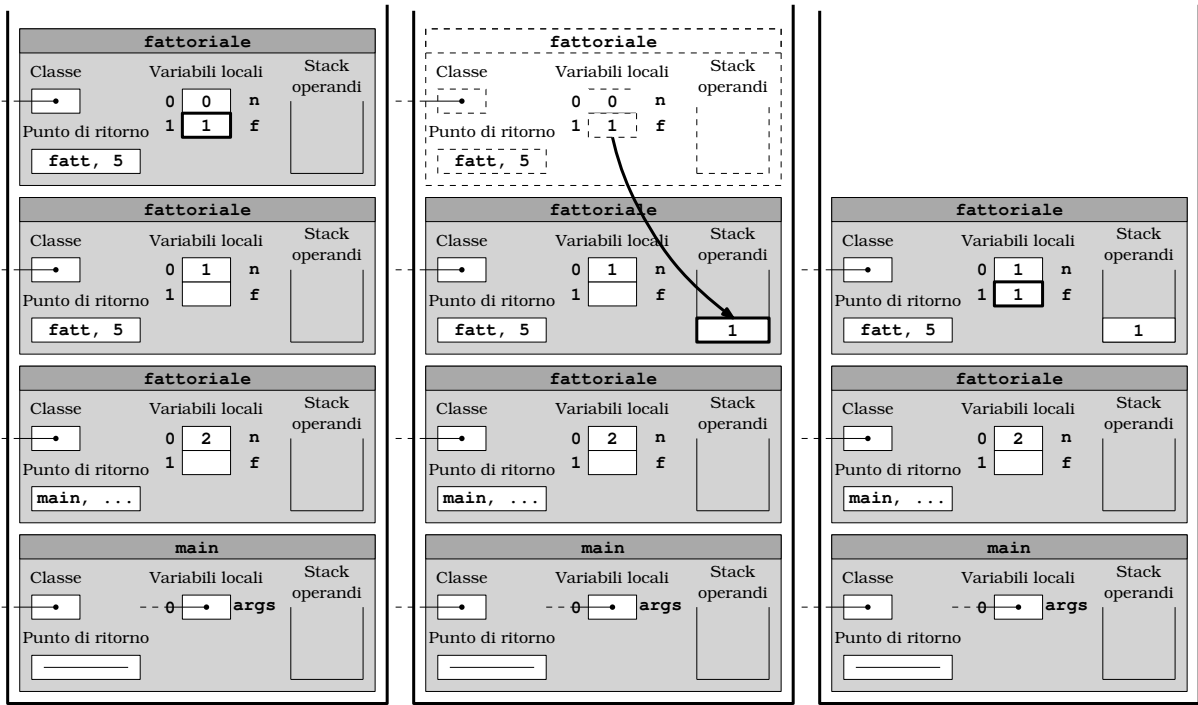

(d)

(e)

(f)

Figura 12.1, pag 335



Figura 12.2, pag 336



Figura 12.4, pag 348

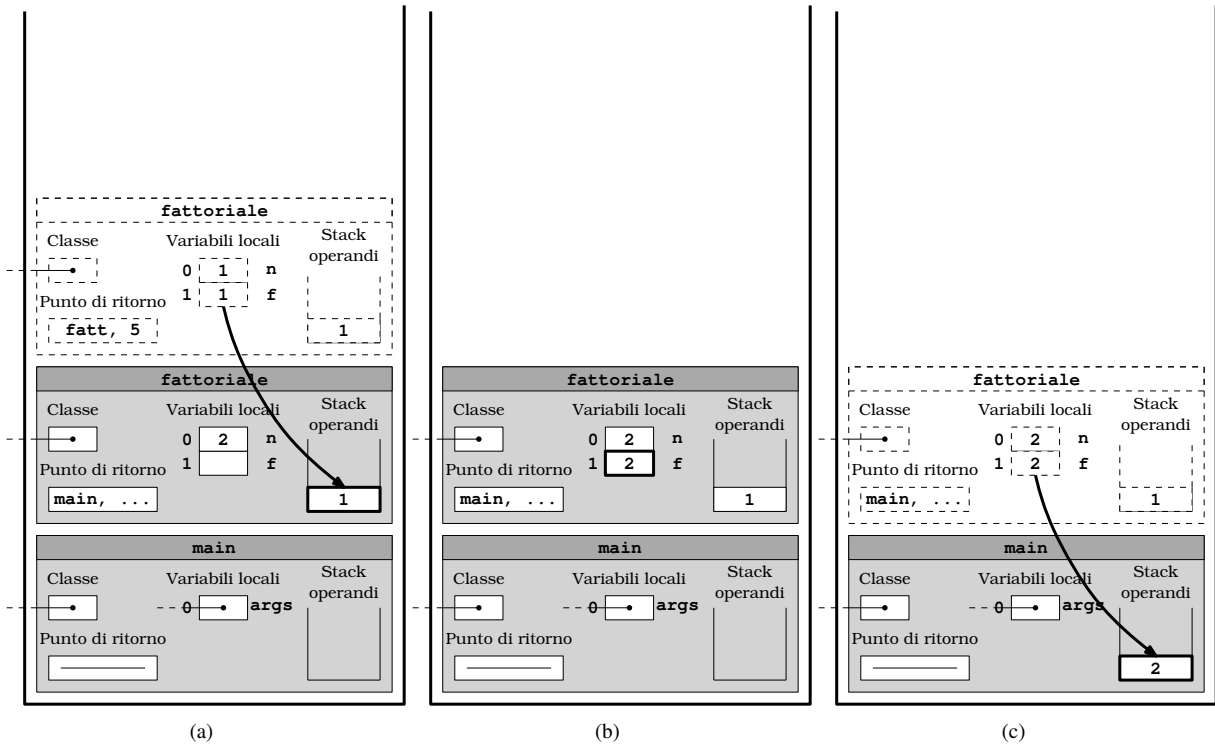

Figura 13.2, pag 371

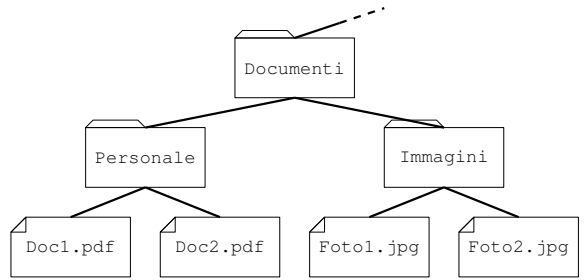

Figura 14.1, pag 387

k=65

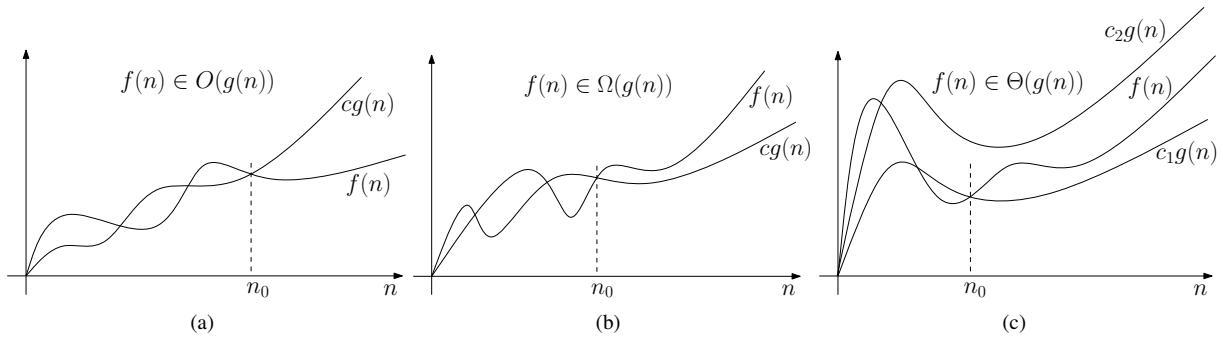

Figura 14.2, pag 388

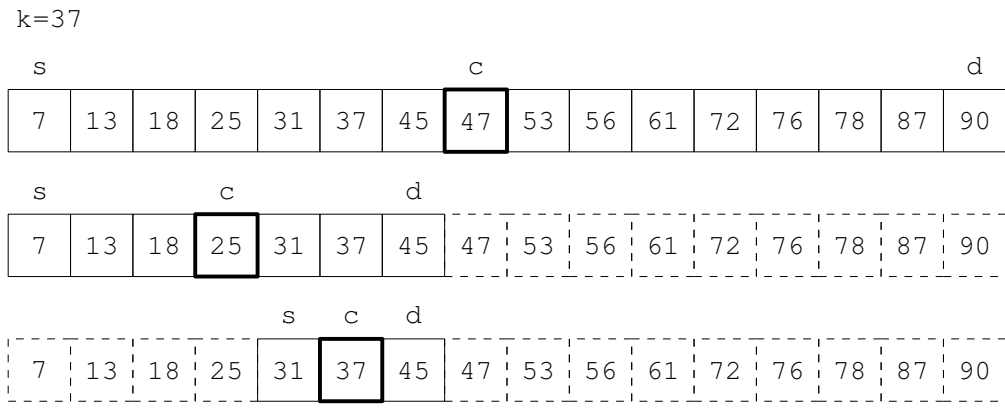

Figura 14.3, pag 390

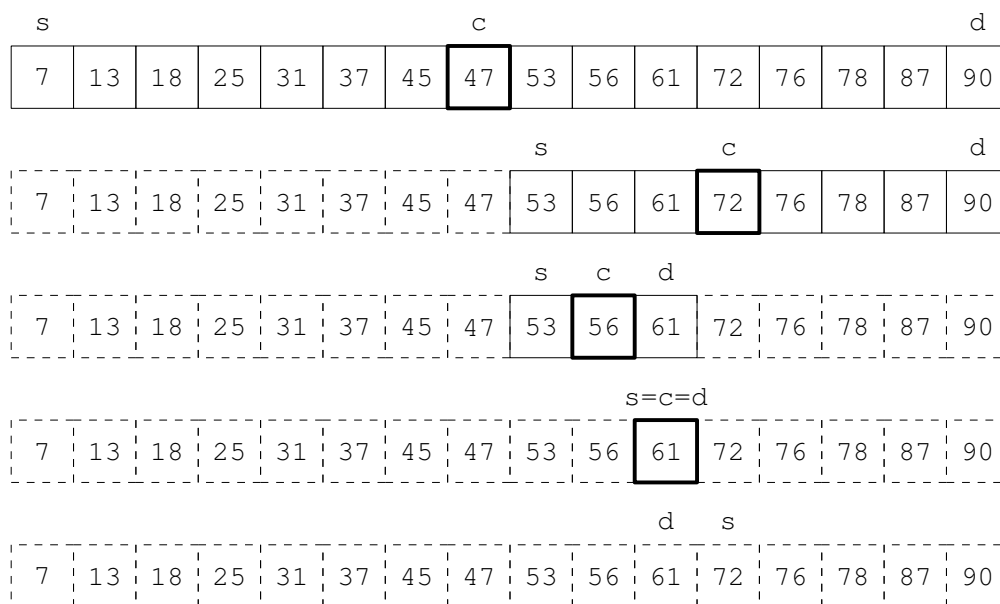

Figura 14.4, pag 393

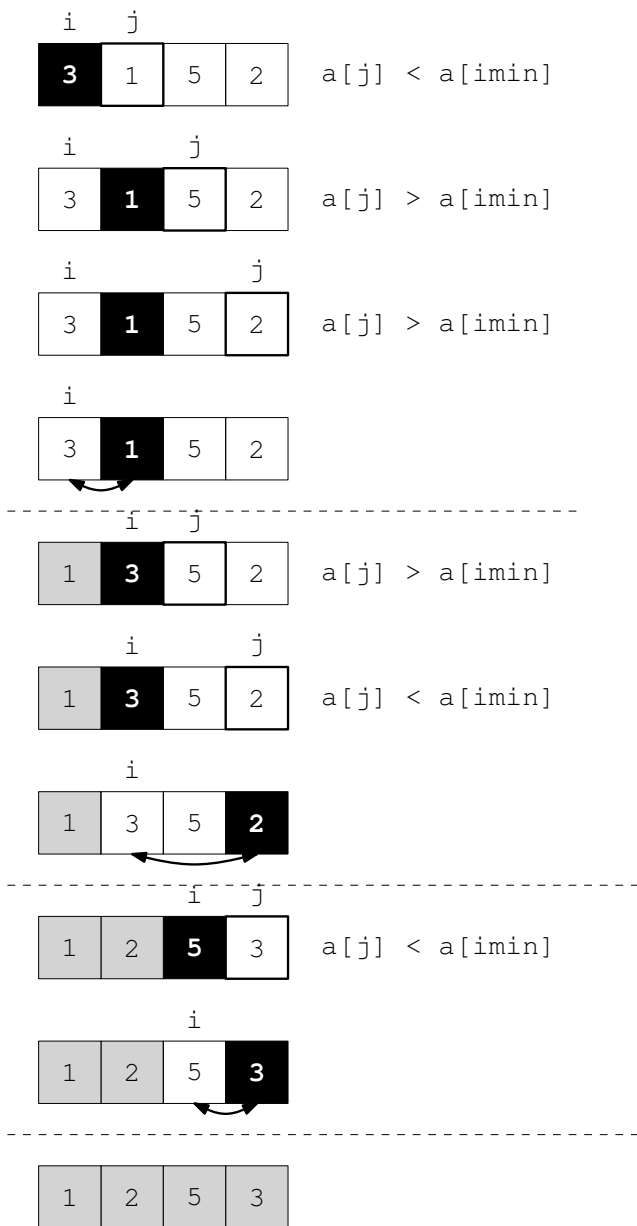

Figura 14.5, pag 397



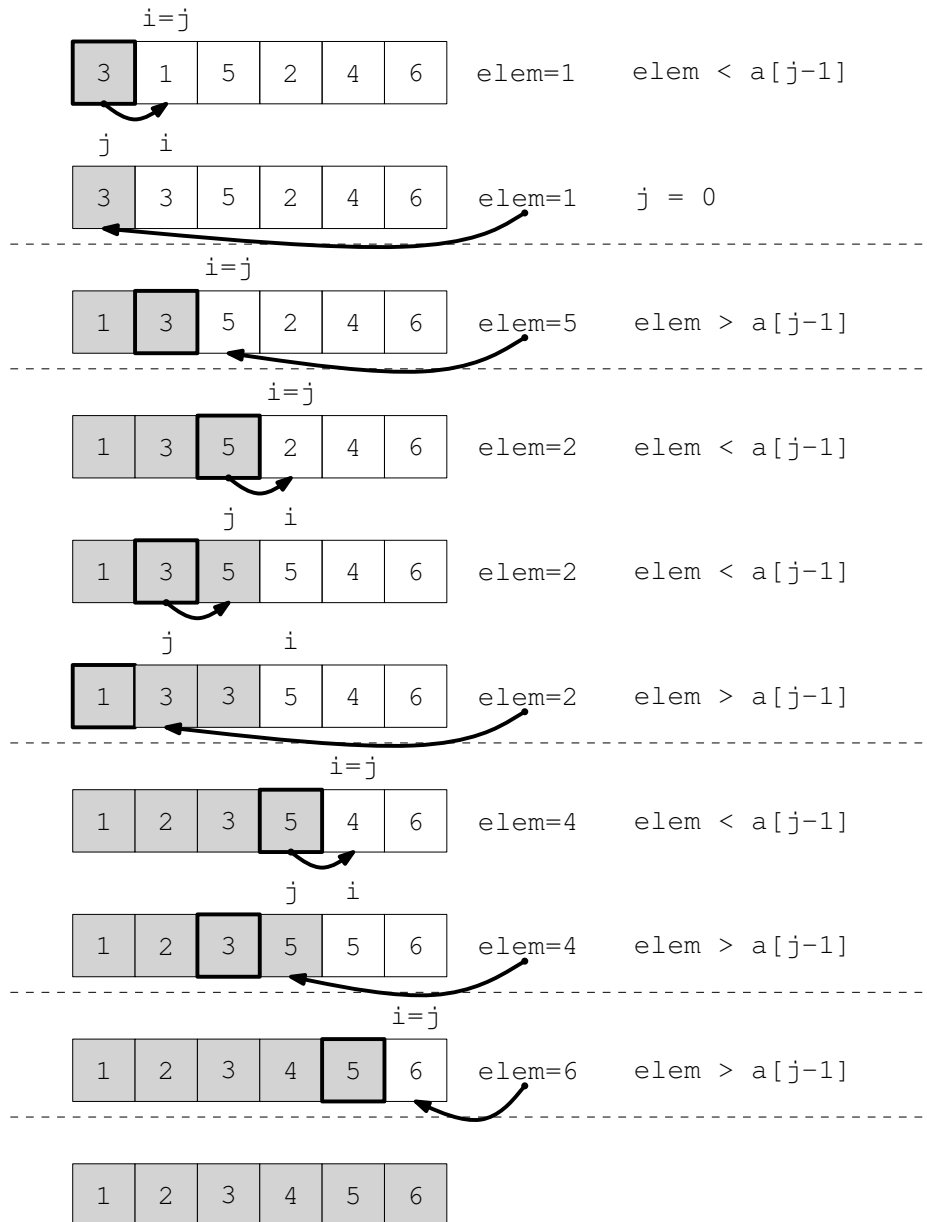

Figura 14.7, pag 403

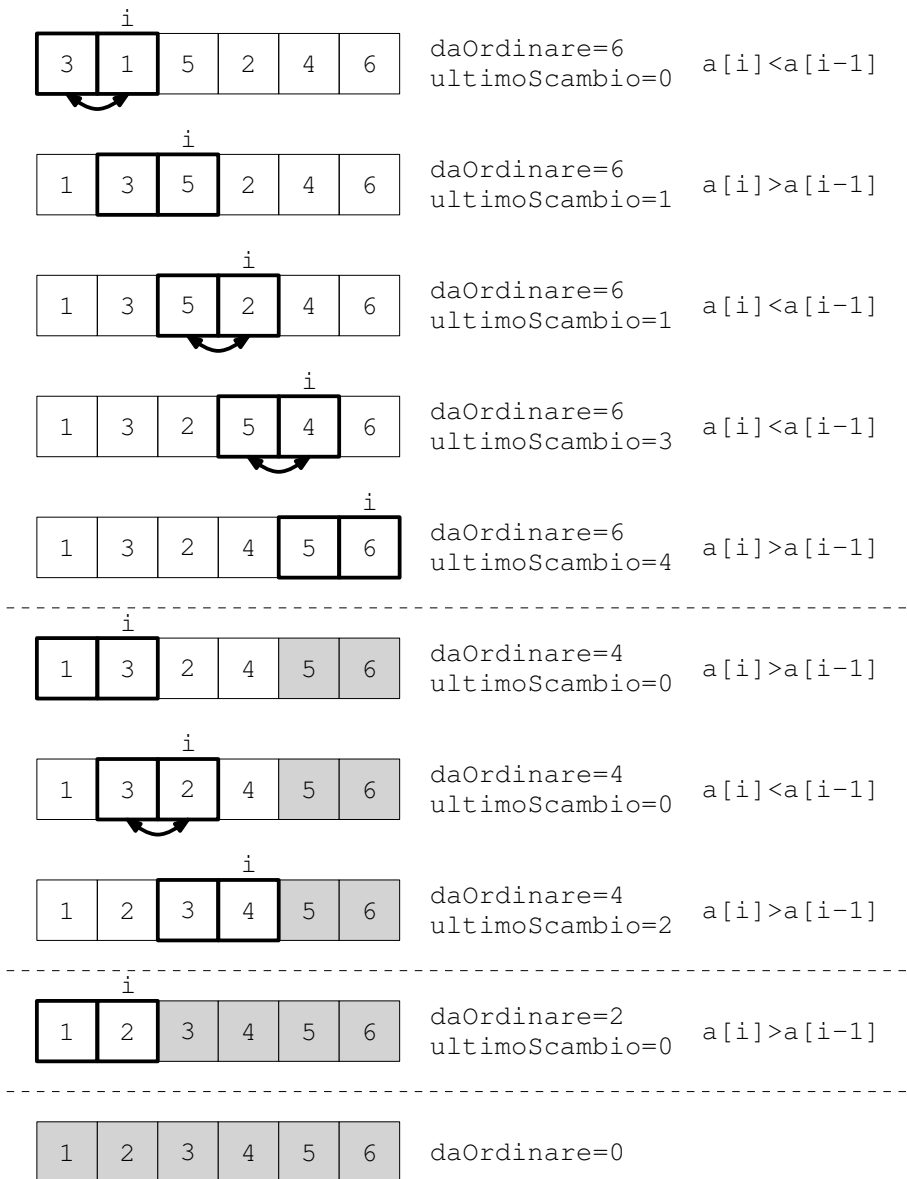
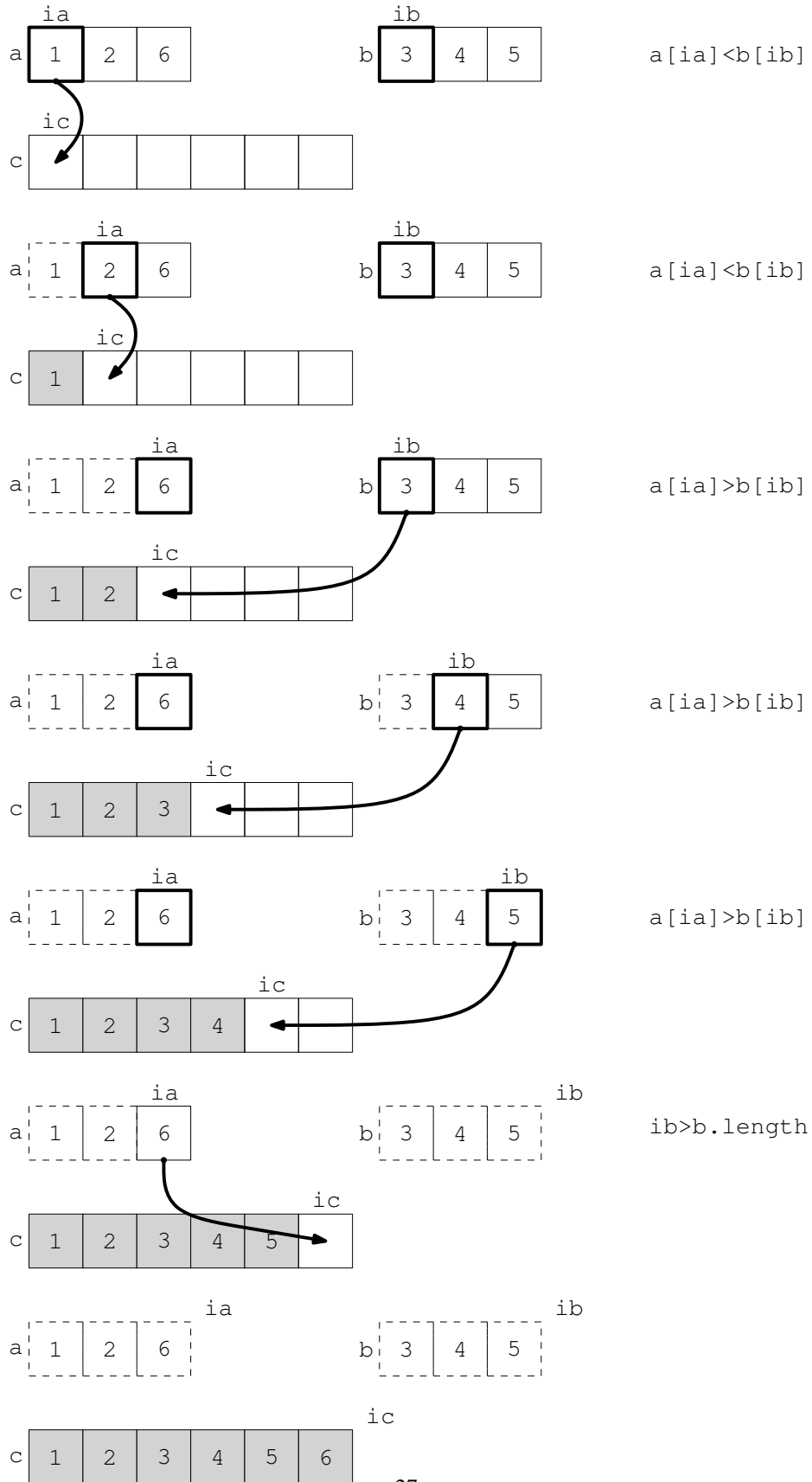

Figura 14.8, pag 404

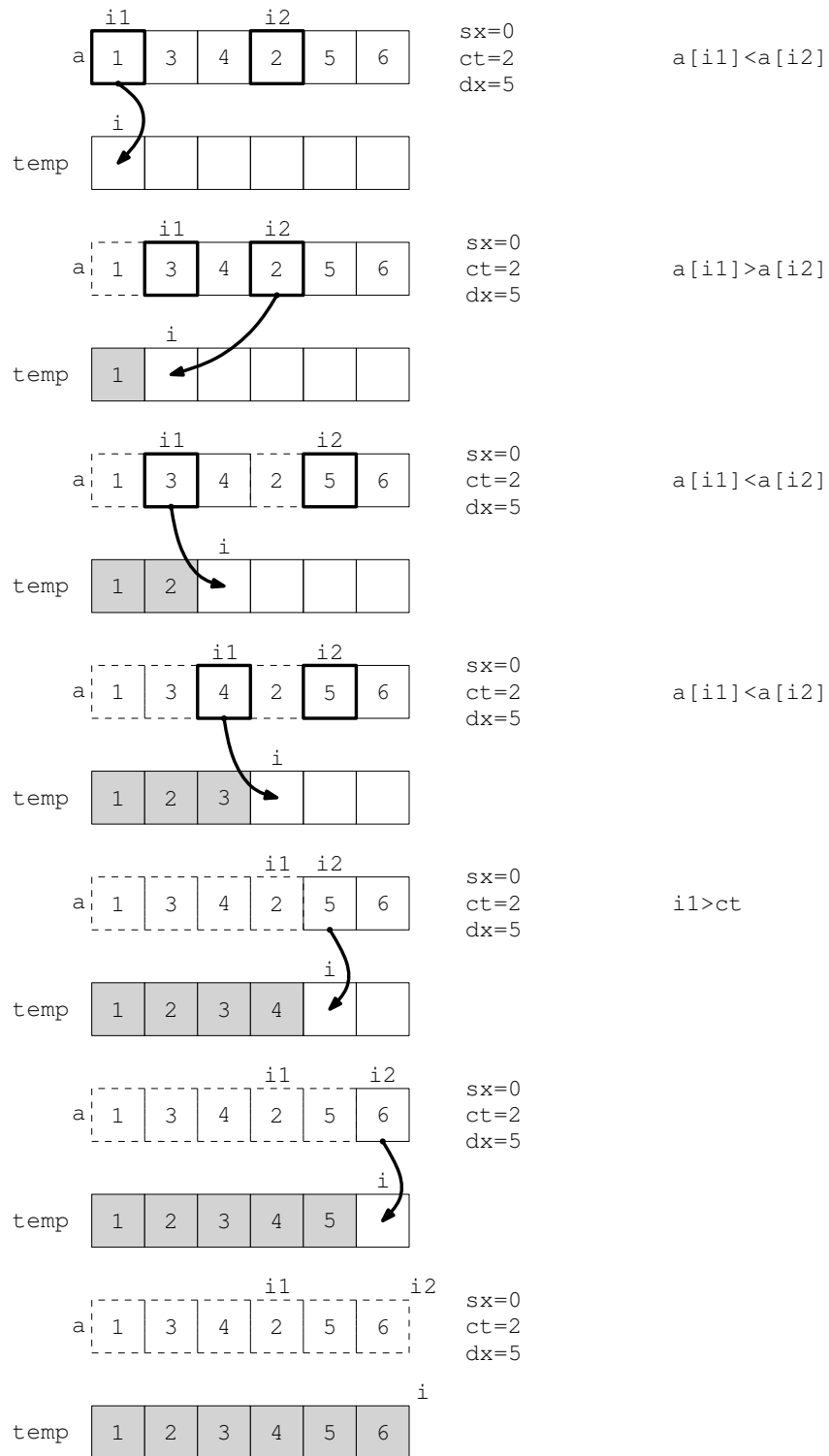

Figura 14.9, pag 407

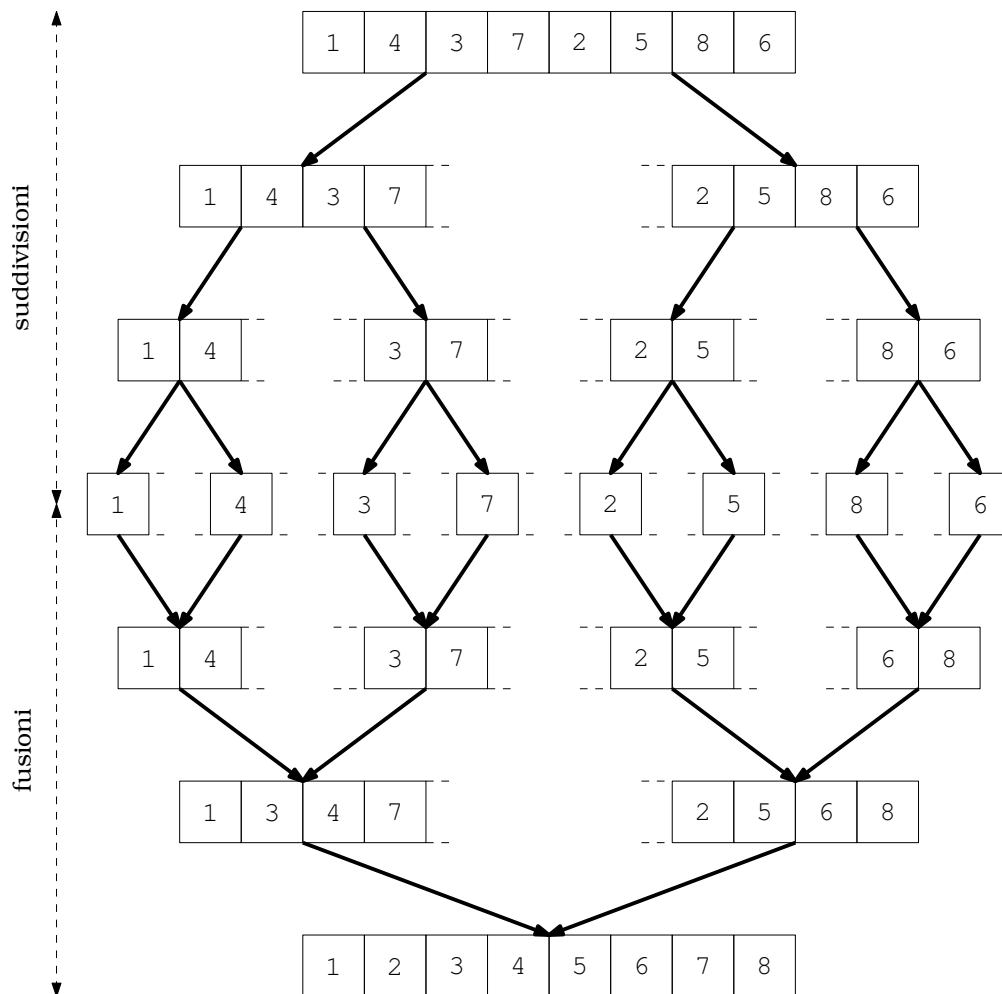

Figura 14.10, pag 408

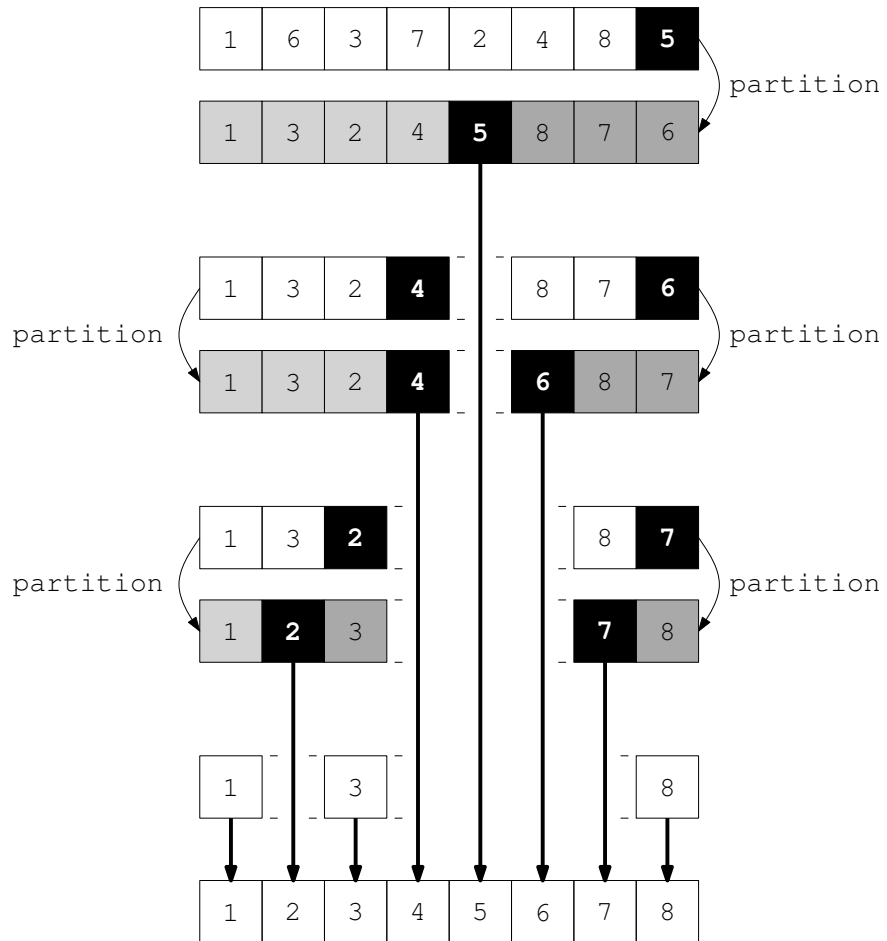

Figura 15.1, pag 420

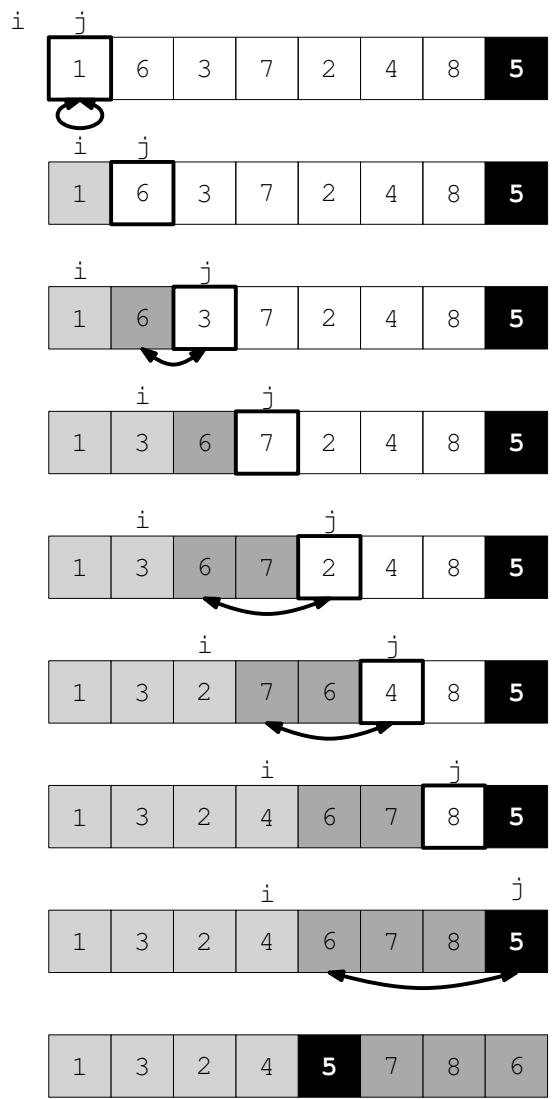

Figura 15.2, pag 423

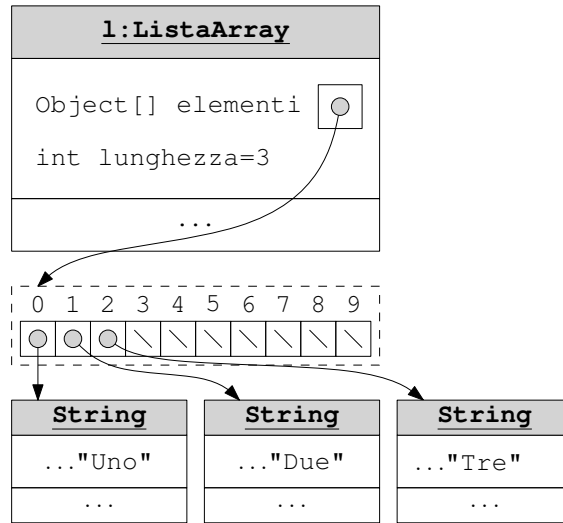

Figura 15.3, pag 424

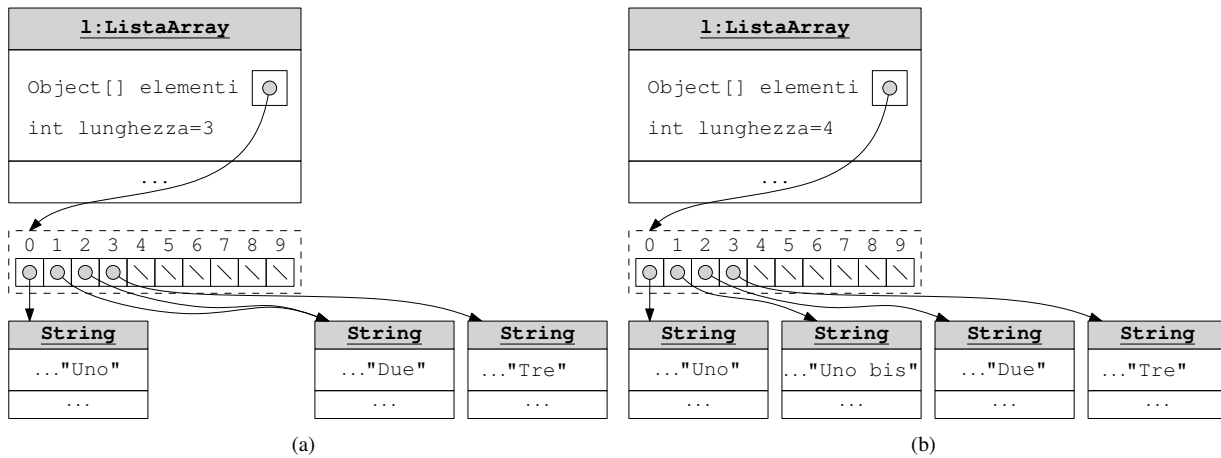

Figura 16.1, pag 494

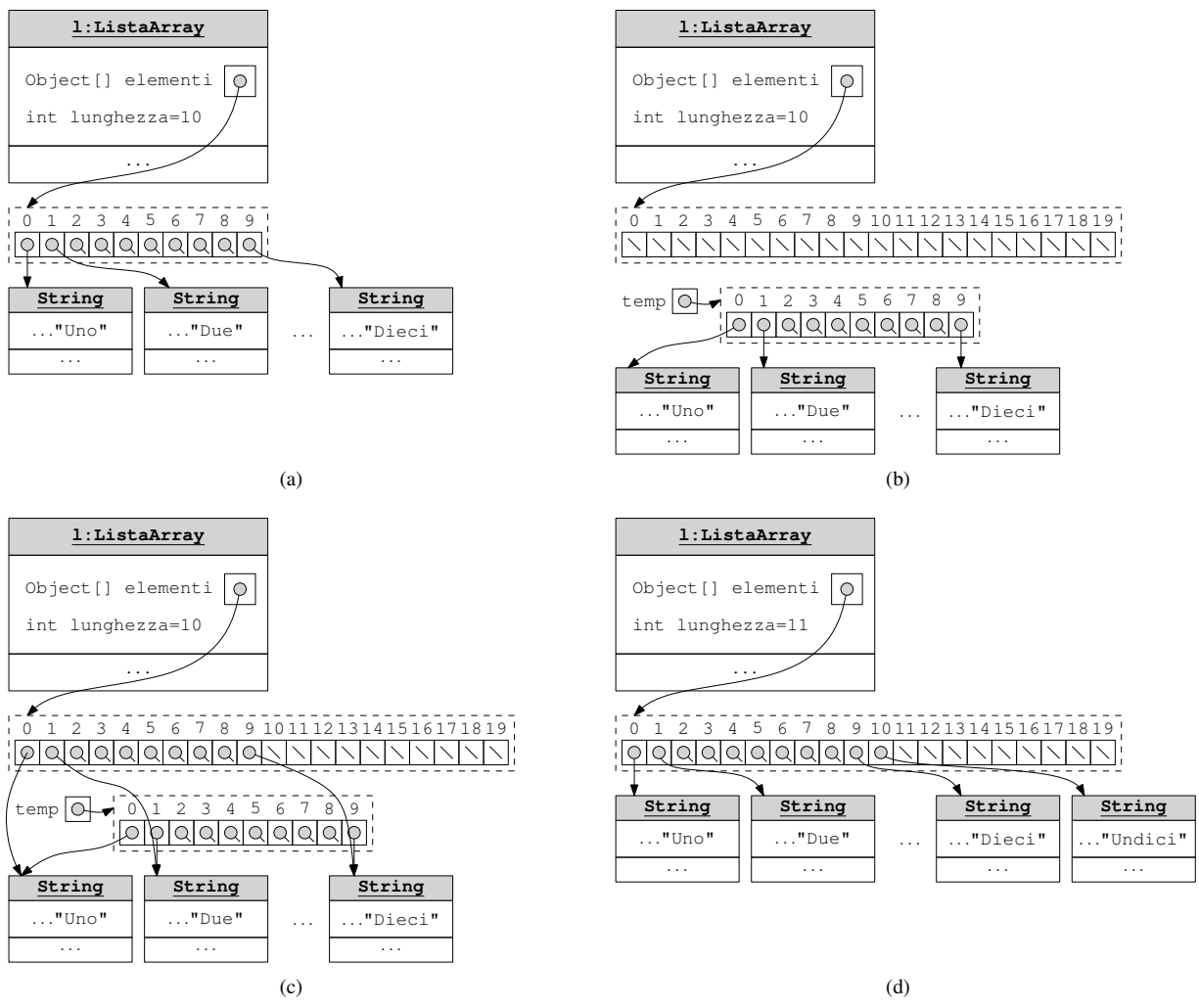

Figura 18.1, pag 523

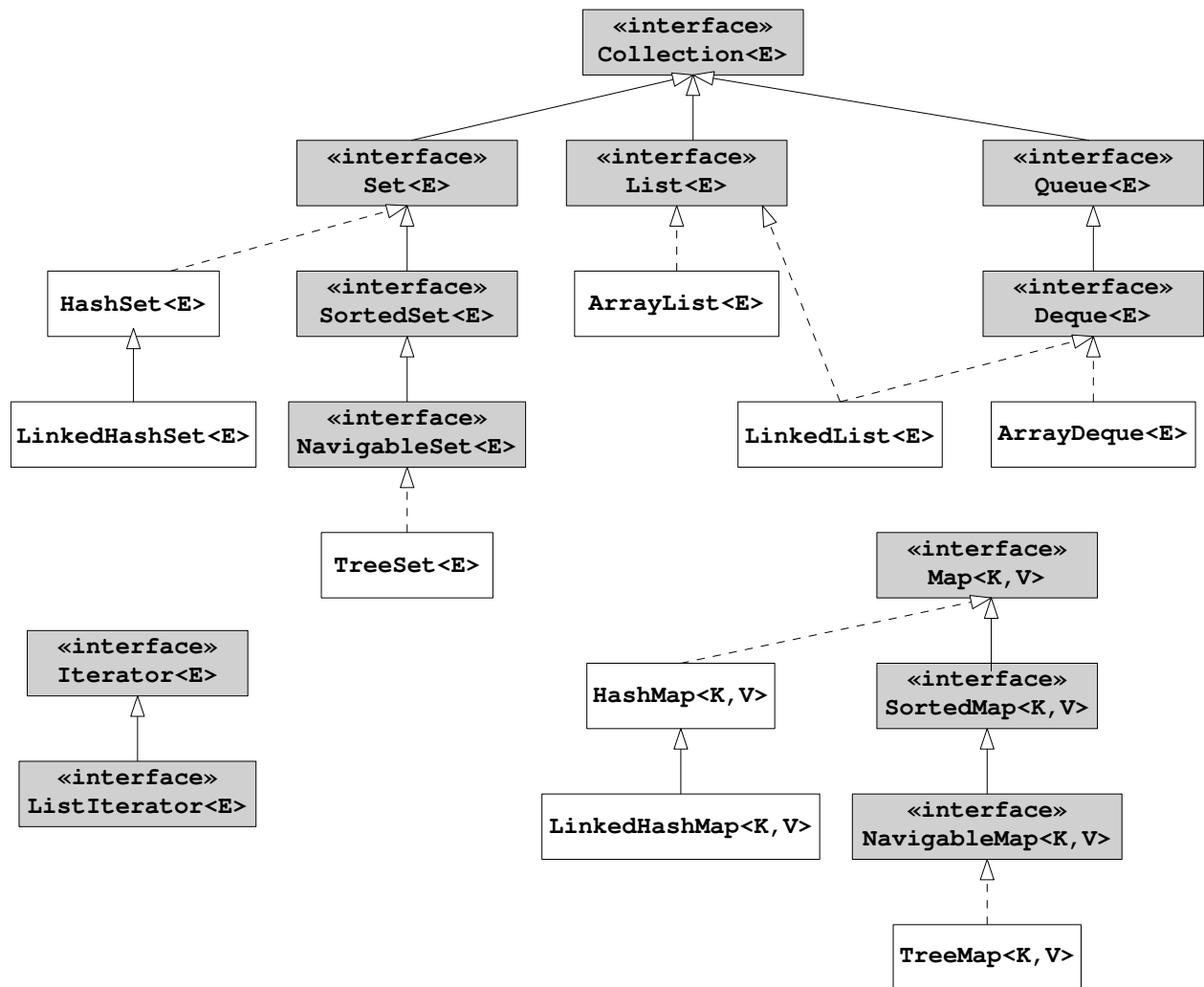
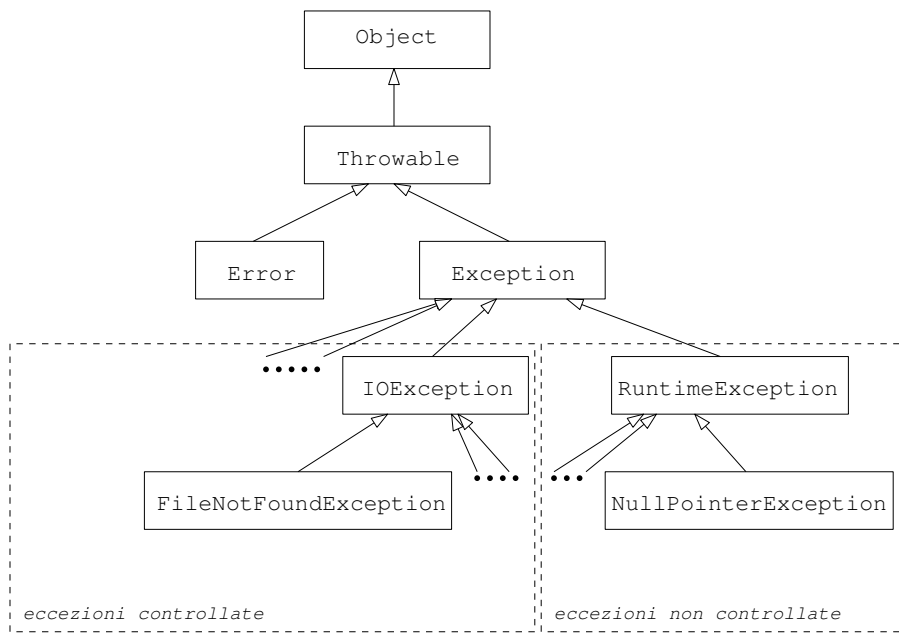
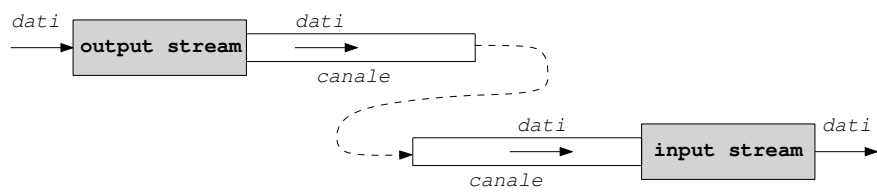

Figura 19.1, pag 542